



TIRE SERVICE SOLUTIONS



2017 TOOL & EQUIPMENT CATALOG

WWW.AMEINTL.NET

352.799.1111

2347 CIRCUIT WAY, BROOKSVILLE, FL 34604



AME INTERNATIONAL - MORE THAN A SUPPLIER



We pride ourselves in working hand in hand with our customers to develop the products which best suit their needs. From our first days, our goal has been relatively simple: Service the Customer. The tools we produce are developed to meet the needs of the people using them each day. We manufacture using the latest technology to ensure high quality standards. Products developed in the field are taken back to the field for further testing and evaluation. The end result is tools and equipment for the tire industry – designed by the tire industry. When working with AME, it is likely you'll speak with a member of our executive sales team. Their expertise in tire changing tools and their use and application cannot be matched.



Our Partners

Throughout the world, AME's partners are recognized as providing quality and value.



AC Hydraulic ^{A/S}
NO COMPROMISE

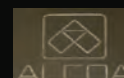



AME INTERNATIONAL GLOBAL IMPACT



AME International is located in Brooksville, Florida. Our marketing, design and engineering activities are centralized here. AME International currently distributes tools and equipment to all major markets around the globe. Chances are you'll see AME outside of the office. We believe in seeing our customers wherever they might be located. We've traveled the world and value the relationships that we have made.



USA



Europe



Ukraine



AME International
Brooksville, Florida,
USA

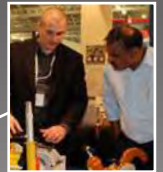

Southeast Asia



Canada

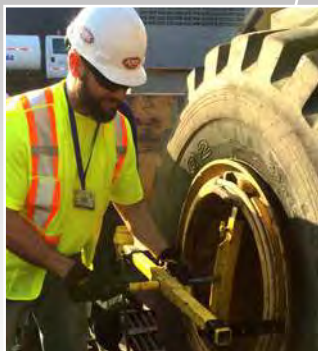

South America



Africa



Asia



Australia



MEET THE AME INTERNATIONAL TEAM

In meeting today's ever-changing wheel design requirements, AME International will continue to develop and design tire tools and accessories in step with the most advanced tire technology to meet customer needs. The AME management team has over 75 years of service to the tire industry.



Keith Jarman
PRESIDENT

Keith is a 23 year industry veteran and TIA Board Member. In 2007, he founded AME International and continues to serve as the company's president.

kjarman@ameintl.net

Office: (352) 799-1111 Ext. 221



AME International Sales Representatives



Luis Goyeneche
VP SALES - INTERNATIONAL

Luis has 14 years in the tire service equipment industry. In 2007, Luis founded AME International and continues to serve as VP of International sales. Luis is fluent in Spanish and supports/assist TIA trainings and safety implementation worldwide. Luis has extensive tire industry experience, including completing TIA OTR service training.

lgoyeneche@ameintl.net

Office: (352) 799-1111 Ext. 224



Brett Waggoner
VP SALES - DOMESTIC

Brett has 14 years in the tire service equipment industry. In 2007, Brett founded AME International and continues to serve as VP of domestic sales. Brett has extensive tire industry experience, including completing TIA OTR service and Michelin OTR training. Brett has extensive knowledge in commercial and automotive wheel/tire service and safety procedures.

bwaggoner@ameintl.net

Office: (352) 799-1111 Ext. 225



Shane Wiley
USA - ASIA / MIDDLE EAST

Shane Wiley has 6 years of tire service experience with AME International. Shane is also TIA OTR trained and has worked extensively in the heavy duty equipment industry for the past 16 years.

swiley@ameintl.net

Office: (352) 799-1111 Ext. 242

TABLE OF CONTENTS



ABOUT AME, MEET THE TEAM & MORE	2-6
HYDRAULIC BEAD BREAKERS	7-17, 19
AGRICULTURAL TOOLS & CALCIUM PUMPS	17-18, 20-21
SERVICE TRUCK PACKAGES	20-25
HYDRAULIC RAMS	26-27
AIR/HYDRAULIC PUMPS	28-32
HYDRAULIC JACKS	33-36
JACK PLATES	37
OTR/MINING TIRE SERVICE	38-51
SAFETY SUPPLIES, CRIBBING & WHEEL CHOCKS	52-65
AIR/HYDRAULIC JACKS, SERVICE JACKS & JACK STANDS	66-71
TIRE INFLATION CAGES & DIGITAL TIRE INFLATORS	72-76
COMMERCIAL TIRE CHANGING TOOLS	77-79
WHEEL DOLLIES/TROLLEYS	80-81
TRUCK TIRE TOOLS & ACCESSORIES	82-89
TIRE LIFE, LIQUID TIRE BALANCER & OTHER TIRE ADDITIVES	90-91
FORKLIFT SERVICE	92
AIRCRAFT / HEAVY DUTY JACKS & JACK STANDS	93
AUTOMOTIVE: TIRE SPREADERS, JACKS, TOOLS & ACCESSORIES	94-108
JACKING BEAMS & CRANES	109
PARTS, REPAIR PROGRAM, BUYBACK PROGRAM & MORE	110-115
INDEX	118-119



TIA CERTIFICATIONS & TRAINING



The Tire Industry Association is committed to providing educational services that will evolve with technology. From training and certification for experienced employees to basic training for new hires, TIA offers programs that can be utilized by large and small companies throughout the tire industry. TIA also offers a wide range of reference materials and training aids to allow members to customize the training to meet their needs.

TIA's Earthmover Training is endorsed by and available from **AME International**



36000 EARTHMOVER TIRE SERVICE TRAINING KIT DVD VERSION

The 3-hour video features 15 different modules that cover the basic safety guidelines for servicing OTR tires, wheels and rims in the field. The video is accompanied by a 200+ page workbook that features hundreds of four-color photos to outline the step-by-step procedures and various industry resources. Students that successfully complete the final exam will receive a TIA Certificate of Completion. Basic ETS is comprised of 15 modules: Introduction, Tires, Rims & Valves, Service Truck Operation, Site Preparation & Equipment Lifting, Hydraulic Bead Breakers & Rams, Service One-Piece on Machine, Service Three-Piece on Machine, Service Five-Piece on Machine, Service Double Gutter on Machine, Service One-Piece Loose, Service Three-Piece Loose, Service Five-Piece Loose, Wheel & Rim Fastening, Systems, Install & Remove Wheel Fitment, Install and Remove Rim Fitment.



36200 BASIC AUTOMOTIVE TIRE SERVICE TRAINING & CERTIFICATE PROGRAM

Basic Automotive Tire Service (ATS) is a 200 Level minimum skills, training and certificate program that outlines and explains the guidelines for servicing passenger and light truck tire and wheel assemblies. Basic ATS is comprised of 10 modules: Introduction, Tires, Wheels & Fasteners, Raising the Vehicle, Tire/Wheel Assembly Removal, Torque & Clamping Force, RIST, Demounting/ Mounting & Inflation, Balance & Run-out, Puncture Repair.

36205 BASIC FARM TIRE SERVICE (FTS)

Basic Farm Tire Service (FTS) is a 200-level minimum skills training and certificate program that outlines and explains the guidelines for servicing farm, agricultural and construction tire and wheel assemblies. It includes the step-by-step procedures for demounting, mounting and inflating single, dual and 3-piece assemblies in addition to service truck operation and liquid ballast installation/ removal.

36100 BASIC COMMERCIAL TIRE SERVICE TRAINING & CERTIFICATE PROGRAM

According to the Occupational Safety & Health Administration (OSHA) Regulation 29 CFR 1910.177, any employee that handles truck tires and wheels must receive safety training and demonstrate their ability to perform the necessary tasks. The Basic Commercial Tire Service (CTS) Training and Certificate Program is designed to meet the minimum federal training requirements for both new hires and experienced employees in need of documented training. Basic CTS is comprised of 12 modules: Safety, Basic Tire Info., Rims and Wheels, OSHA Regulations, Jacking and Lifting, Torque, Wheel End Safety, Hub-Pilot Wheels, Stud-Pilot Wheels, Demountable Rims, Single-Piece, Multi-Piece.

BEAD BREAKERS: INTRO TO 3 PIECE WHEELS



"COMBI" BEAD BREAKER

"Combi" Bead Breakers are named as such as they work on a combination of different wheels. They can be used on **single, two and three piece wheels and rims**. Also known as 'Farm Tools' or even a '210 Tool,' these bead breakers are used on truck, bus, farm and small construction wheels.

Unlike the 5 piece wheel bead breakers, Combi bead breakers push the tire away from the wheel. The tools have two hydraulic cylinders, with the first one clamping the tool onto the wheel. Once clamped onto the wheel, the hydraulic pressure actually pulls the teeth of the bead breaker into the tire and wheel. The second cylinder is then activated and the bead breaker foot pushes against the tire, separating it from the wheel. While some tire fitters have used this tool on smaller 5 piece wheels, it is designed for use only on single, 2 and 3 piece wheels.

"COMBI" BEAD BREAKERS ARE USED TO DISMOUNT THE FOLLOWING SIZE TIRES:

This is not a complete list

9.5L-14	9.5-16	54 x 37.00-25	35.5L-32
11L-14	18.4-34	66 x 43.00-25	20.8-38
5.00-15	11.00-16	385/95R25	18.4-42
5.90-15	4.00-18	445/95R25	20.8-42
6.70-15	12.5/80-18	505/95R25	18.4R46
7.5L-15	7.50-20	17.5R25	320/90R50
9.5L-15	11.25-24	20.5R25	380/90R50
10.00-15	12.4-24	21L-28	
11L-15	16.9-24	24.5 x 32	
12.5L-15	14.00R24	30.5L-32	

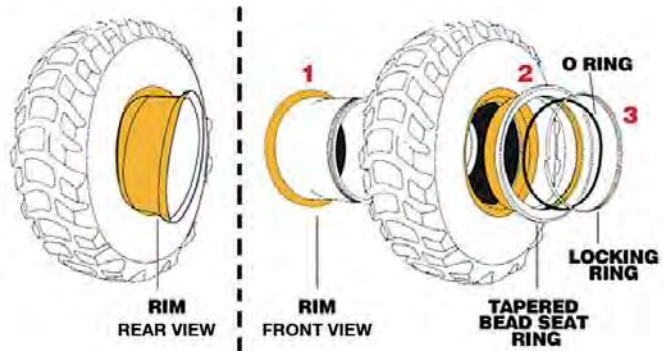



HYDRAULIC BEAD BREAKERS: 3 PIECE WHEELS



11010

"COMBI" TIRE BEAD BREAKER

- Most popular tool for breaking beads on all agricultural wheels
- Used on construction wheels up to 25"
- Works on single, 2 and 3 piece wheels
- Tool clamps hydraulically to the wheel and then breaks bead with 11 tons of force
- 3.75" (9.5 cm) stroke length
- Used with 10,000psi (700 bar) air/hydraulic pump
- Weight: 38 lbs (17.24 kg)



11015

TITAN FARM TIRE BEAD BREAKER

- Ideal for tire dealer who requires occasional use of bead breaker
- 10 ton cylinder has enough force to break most beads
- 4" (10 cm) stroke length
- Unit will break all single and 2 piece and most 3 piece wheels
- Weight: 39 lbs (17.69 kg)



75005

"THE WEDGIE" TIRE BEAD WEDGE

- Used to assist in breaking beads on earthmover, ag, construction and forestry tires
- Simple yet effective device
- High Impact Nylon Material
- Weight: 10.4 oz.
- #75010: Case of 16 Wedges

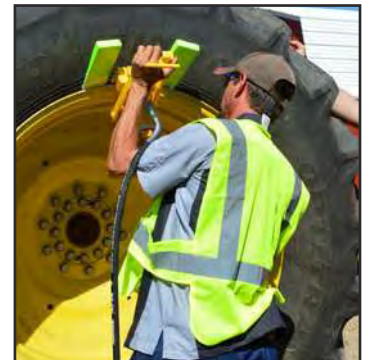

11020

MODIFIED "COMBI" TIRE BEAD BREAKER

- The tool operators are most familiar with
- Most parts interchange with common bead breakers in the market
- Least expensive bead breaker for new 3 piece wheels
- Larger clamp and feet allow tool to easily clamp onto wheels
- Compact design allows tool to be used on front or back side of wheel
- Weight: 38 lbs (17 kg)



11090

"STINGER" BEAD BREAKER

- Lightweight option for breaking 3 piece wheels
- Shipped with tool box
- Unit mechanically clamps to wheel, regardless of size or clearance
- 10 ton, 8" (20 cm) stroke cylinder pushes bead back away from the wheel
- Unique head is designed for tool to push on the bead - not the side wall of tire
- Comes with 2 spacer wedges to prevent bead from re-seating
- Weight: 39 lbs (17.69 kg)



11076

DIAMONDBACK ALUMINUM BEAD BREAKER

- Best solution for today's larger 3 piece wheels
- Lightweight aluminum reduces weight by 40%
- Longer feet allow better fit onto wheel/rim
- Feet fully engage rim flange and push against the bead of the tire
- Comes with protective carrying case
- Weight: 42 lbs (19.05 kg)





BEAD BREAKER UPGRADE KITS & COMMON PARTS



16200 UPGRADE KIT FOR 3 PIECE WHEELS

- Converts standard Combi style bead breakers to fit 3 piece wheels
- Easy to change - no need to send in for service
- Will fit models from IMT, FEC, Stellar and Esco
- Includes #16150 Kit to guarantee fit on all tools - regardless of age



16150 CONVERSION KIT FOR COMBI BEAD BREAKERS

- Kit increases opening on Combi Style Bead Breakers
- Will fit models from IMT, FEC, Stellar and Esco
- Can be added to tool in minutes-easy to apply



11077 VOLVO ADAPTER

- Used on back side of certain assemblies
- Ideal for low clearance sections
- Adapter easily changes out on 11076 Bead Breaker



17200 DIAMONDBACK BEAD BREAKER UPGRADE KIT

- Will work with existing Aluminum Bead Breakers, including AME model 11076 and IMT-1000
- Longer feet allow the tool to fully engage the bead of the tire
- Helps tool to push on the bead – not the sidewall
- Installation instructions included



TOOL TALK: 5 PIECE WHEELS



5 PIECE WHEEL BEAD BREAKERS

5 Piece Wheel Bead Breakers are unique in that they typically **push the rim flange off of the bead seat band, breaking the bead without touching the tire.**

These tools have one single hydraulic cylinder to push back the rim flanges on the front and back side of the tire. Tools are most often held into place with a hook that fits into a pocket on the wheel, although some tools that clamp to the rim flange exist.

5 PIECE WHEEL BEAD BREAKERS ARE USED TO DISMOUNT THE FOLLOWING SIZE TIRES:

This is not a complete list

23.5R25	33.5-33	37.5R39	33.00R51
26.5R25	36/65-33	40.5/75R39	36.00-51
750/65R25	35/65R33	40/65-39	36.00R51
29.5R25	37.5-33	41.25/70-39	50/65-51
26.5-29	875/65R33	45/65R39	37.00R57
29.5-29	21.00-35	1150/65R45	40.00R57
29.5R29	21.00R35	45/65-45	46/90R57
30/65-29	24.00-35	45/65R45	50/80-57
33.25-29	24.00R35	21.00-49	52/80-57
33.25R29	29.5-35	24.00-49	55/80R63
775/65R29	33.25-35	24.00R49	58/80R63
800/65R29	33.25R35	27.00-49	59/80R63
875/65R29	37.25-35	27.00R49	
18.00-33	37.25R35	30.00-51	
18.00R33	1150/65R39	30.00R51	
21.00R33	37.5-39	33.00-51	

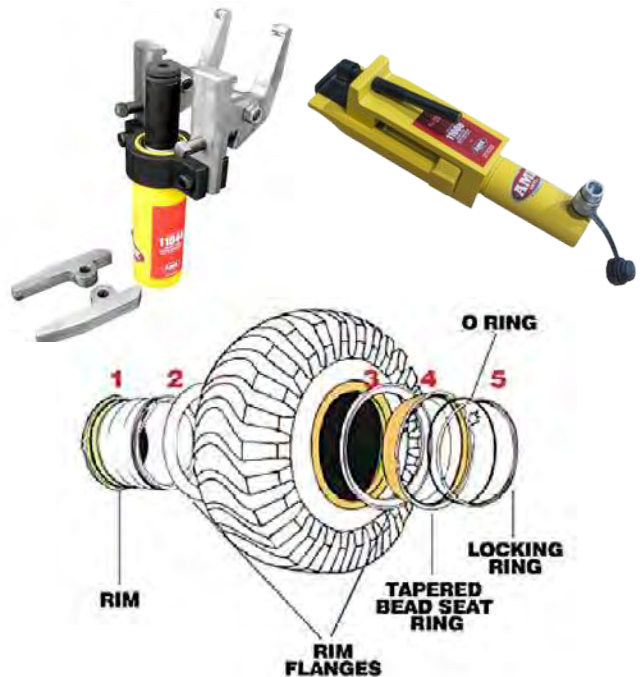



HYDRAULIC BEAD BREAKERS: 5 PIECE WHEELS



Adapter (#16070) for use with 11000 on Caterpillar Shur-Lok rims (Sold Separately)

11000 OTR GIANT TIRE BEAD BREAKER

- Most popular tool for breaking beads on earthmover tires, sizes 25"-51"
- Works only on 5 piece wheels with bead loosening pockets
- 4 1/4" (10.8 cm) stroke ram
- Use with any 10,000 psi (700 bar) air/hydraulic pump
- Weight: 30.6 lbs (13.88 kg)



#A-64
10,000 PSI Tee Fitting
Included

12105 DUAL 11000 OTR GIANT TIRE BEAD BREAKER KIT

- Breaks the bead on 5 Piece Wheel assemblies at two points of contact
- Model #A-64: 10,000 PSI Tee fitting assures equal oil pressure to both units
- 5 Quart Pump provides enough oil capacity for both bead breakers
- Comes with (3) 8' hydraulic hoses rated at 10,000 PSI each (proper couplings included)



HYDRAULIC BEAD BREAKERS: 5 PIECE WHEELS



11001

ALUMINUM 5 PIECE BEAD BREAKER

- Used on 25"-51" 5 piece wheel assemblies
- "Thinner" hook allows for use on smaller bead pockets
- 4 bead pocket hooks available for a range of wheel styles
- Includes 2 aluminum bead wedges, AME model #11001-021
- Works only on 5 piece wheels with bead loosening pockets
- Weight: 30.3 lbs (13.74 kg)

Part #	Width	Length
11001-022	1-15/16" (49.3 mm)	1-9/16" (39.62mm)
11001-023	1-15/16" (49.3 mm)	2-9/16" (65.02mm)
11001-024	1-7/16" (36.58 mm)	1-1/2" (38.10mm)
11001-006	1-15/16" (49.3 mm)	1-9/16" (39.62mm)



11005

TITAN EARTHMOVER BEAD BREAKER

- Ideal for tire dealer who requires occasional use of a bead breaker
- 10 ton cylinder has enough force to break most beads
- 4" (10 cm) stroke length
- Works only on 5 piece wheels with bead loosening pockets
- Weight: 29 lbs (13.15 kg)



11050

OTR GIANT TIRE BEAD BREAKER

- Compact, lightweight tool used primarily on 25" and 29" earthmover wheels
- Originally marketed as Goodyear TO-1600-HA
- Works only on 5 piece wheels with bead loosening pockets
- 2 1/8" (5.4 cm) stroke, 10 tons of hydraulic force
- Used with 10,000 PSI (700 bar) air/hydraulic pump
- Weight: 23 lbs (10 kg)





HYDRAULIC BEAD BREAKERS & ACCESSORIES



16270 OTR 2000 UPGRADE KIT

- Upgrade kit for model #11030 for larger rim flanges on 63" assemblies
- Easily installed on model #11030 OTR 2000 Bead Breaker
- Kit includes Extended Pushing Spade, and (2) extended bead pocket hooks



11055 KOMATSU 930E BACK SIDE TIRE BEAD BREAKER

- 25 ton cylinder with 8" stroke
- Angled base mounts to Komatsu 930E angled frame which results in a straight push
- Cylinder clamp with 2 mounting rings to chain onto the equipment
- Specifically designed for use with "Speed Wheels" on Komatsu 930E Trucks
- Weight: 32.7 lbs (14.83 kgs)



*Back section jaws included

11044 OTR-3000 GIANT TIRE BEAD BREAKER

- Designed specifically to work on Topy and Rimex OE wheels found on Terex, Komatsu, Liebherr and Le Tourneau
- Designed to prevent tool from kicking out while under load
- 25 ton cylinder, 6" Stroke ram delivers maximum force
- Jaw design works on most wheels 51"-63"
- Weight: 55 lbs (24.95 kg)



11046

OTR-3000 BEAD BREAKER JAW ASSEMBLY - STANDARD

- Contains two jaws for back section and bead bands
- High chromoly steel ensures structural integrity in the toughest conditions
- Fits majority of 5 Piece OTR Wheel assemblies
- Not to be used on CAT Shur-Lok assemblies (see AME #11043)

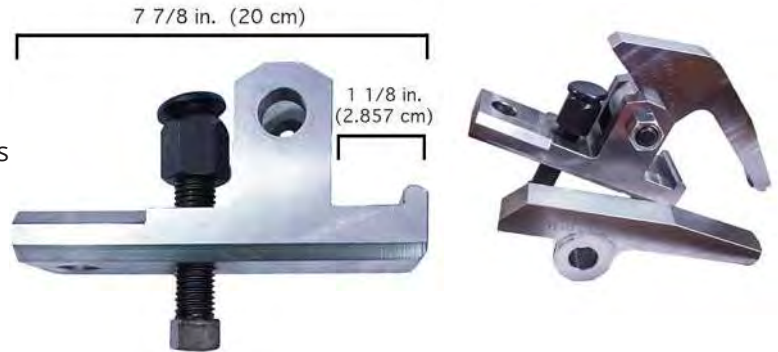

11043

OTR-3000 CAT SHUR-LOK BEAD BREAKER JAW

- Extended clamping frame fits over Shur-Lok Bead Bands
- High chromoly steel ensures structural integrity in the toughest conditions
- Order model #11049 for OTR-3000 Bead Breaker already fitted with Shur-Lok Jaws



11144 ADAPTER FOR TOPY WEDGE WHEEL BEAD BREAKER EXTENSION

- Designed to work on TOPY Wedge Wheels
- Does not scar/contact rim base
- Shorter rim flange sections
- Can be added to 11044 in minutes, thread in install

11145 BEAD BREAKER EXTENSION

- Used on TOPY Wedge Wheels size 49"-63"



11244 ADAPTER FOR 11044 TITAN SVM/OVM WHEEL

- Does not scar/contact rim base
- Designed to work on narrow bead seat bands
- Can be added to 11044 in minutes, snap in install

11344 ADAPTER FOR 11044 RIMEX DGS WHEELS

- Does not scar/contact rim base
- Designed to work on narrow bead seat bands





HYDRAULIC BEAD BREAKERS: 5 PIECE WHEELS

11040

OTR TIRE BEAD BREAKER

- Original earthmover tire bead breaker
- Originally marketed as Goodyear TO-100-HA
- Tool clamps to wheel mechanically and then the hydraulic ram assembly is used to break the bead
- Designed for use on 5 piece wheels which do not have bead loosening pockets
- Tool offers 10" (25.4 cm) of stroke to break the bead
- Includes 6 curved wedges which are used to prevent tire from 're-seating' when the tool is moved around the wheel for additional bead breaking
- Used with 10,000 PSI (700 bar air/ hydraulic pump or hand operated hydraulic pump)
- Model 12150 – Frame Assembly only (TO-100-FA)
- Model 12160 – Ram Assembly only (TO-100-RA)
- Weight: 65 lbs (29.48 kg)



Frame assembly available. For complete parts breakdown, visit www.beadbreakers.com



11030

OTR GIANT TIRE BEAD BREAKER

- Bead breaker for use on earth mover wheels from 39" to 63"
- Originally marketed as TO-2000-HA or OTR-2000
- 25 ton, 6" (15.25 cm) stroke breaks all beads
- Used with large capacity (5 quart or more) 10,000 PSI (700 bar) air/hydraulic pump
- Available in 8" Stroke model #11031
- Weight: 52 lbs (23.5 kg)
- #16270 Kit available (sold separately)



#16270 Kit has longer hooks and spade in order to fit onto 63" wheels (Sold Separately)



11060

DUAL AGRICULTURAL TIRE BEAD BREAKER

- Guaranteed to break any dual ag tire beads regardless of vehicle
- Unique compact design allows the tool to fit in the tightest spaces - only 3" (7.6 cm) wide at narrowest point
- Can also be used to break inside bead of inside tire, when tool is placed against the frame of vehicle
- Spreads to 26" (66 cm) in width - enough to break any bead
- Used to break the inside bead of the outside tire on a dual assembly
- 10 Ton cylinder has enough force to break all tractor beads
- Used with 10,000 PSI (700 bar) air/hydraulic pump
- Weight: 39 lbs (17.6 kg)



11002

ALUMINUM MINI BEAD BREAKER

- Detaches inside and outside truck and tractor tire beads from rims with 2 cm extension with magnet and 4 cm piston stroke
- Aluminum construction is lightweight for easy one-man operation
- Compact design to fit in between dual tires



11065

DUAL AGRICULTURAL 300 TIRE BEAD BREAKER



- Lightweight and easy to handle
- Designed for all agricultural applications
- Requires only 4 1/2" (11.5 cm) operating space
- 5 Tons of pushing force
- Opens to 12" (30.5 cm) wide
- Weight: 20 lbs (9kg)



11080

BEAD PUSH OFF TOOL

- Lightweight tool for removing combine and tractor tires after breaking the bead
- Use with any 10,000 PSI (700 bar) air/hydraulic pump
- 4 Tons of hydraulic force
- 5.5" (13.97 cm) stroke
- A removable handle for storage
- Weight: 9 lbs (4.1 kg)





CALCIUM CHLORIDE PUMPS & ACCESSORIES



15090

GRACO CALCIUM CHLORIDE PUMP

- 50 gallon (189 liter) per minute capacity;
- 1 to 1 ratio double diaphragm pump
- Pump only - #15091
- Weight: 38 lbs. (17.2 kg)



15100

YAMADA CALCIUM CHLORIDE PUMP

- 40 gallon (152 liter) per minute capacity; 1 to 1 ratio double diaphragm pump
- Pump only - #15101
- Weight: 38 lbs. (17.2 kg)



15095

CALCIUM CHLORIDE 4-WAY GUN

- Anodized aluminum outlasts brass and poly valves
- Buna-N seals outlast ordinary rubber seals
- Can be used with any existing calcium pump system (such as the 15090 or 15100)
- Calcium pumps outfitted with the model #15095 will be able to transfer: Calcium chloride, Methanol, Anti-Freeze, RimGuard, Water & Beet Juice



15096

310 CORE INJECTOR GUN

- 1/2" female pipe thread
- Attaches to calcium chloride pump for easy extraction of valve
- Securely holds the valve core in the gun body during tire filling or evacuation



15097

1" MALE QUICK CONNECT

- 1" threads will work on any AME calcium pump
- Quick Connect allows for easy switch of pickup side and fill side



15098

1" FEMALE QUICK CONNECT

- 1" threads will work on any AME calcium hose assembly
- Allows for easy disconnect of hose for switch of pickup and fill side



BEAD BREAKER & PUMP - COMBINATION KITS



ANY AME PUMP CAN BE USED TO WORK WITH OUR BEAD BREAKERS.

Shown below are our most popular kit combinations.

	 11000	 11010	 11015	 11020	 11030	 11044	 11076
 15000	12070	12000	12005	12002	12003	12004	12007
 15001	12091	12052	12053	12054	12051	12041	12056
 15025	12058	12059	12061	12063	12064	12066	12067
 15040	12011	12012	12013	12014	12055	12040	12016
 15900	12017	12010	12018	12019			12022
 15905	12033	12034	12025	12036			12039
 15920	12090	12020	12023	12021	12050	12045	12065
 15924	12038	12024	12041	12042	12043	12044	12046
 15925	12075	12015	12030	12047	12048	12049	12050
 15940	12026	12027	12028	12029	12057	12047	12032

* Each kit includes 8' Hydraulic Hose & Coupler



AG/SMALL OTR TRUCK PACKAGE



#MWAGTP AG/SMALL OTR TRUCK PACKAGE



AG/SMALL OTR TRUCK PACKAGE



LIST OF COMPONENTS INCLUDED IN THE #MWAGTP

PART NUMBER	DESCRIPTION	QUANTITY INCLUDED
11000	OTR Giant Tire Bead Breaker	1
11010	"Combi" Tire Bead Breaker	1
11080	Bead Push Off Tools	1
13005	75 Ton Aluminum Jack, 6" Stroke	1
13040	10 Ton Hydraulic Cylinder, 8" Stroke	1
13050	10 Ton Hydraulic Cylinder, 10 ^{1/8} " Stroke	1
13060	30 Ton Hydraulic Cylinder, 2" Stroke	1
13075	10 Ton Low Profile Cylinder Kit, Steel	1
13120	55 Ton Aluminum Jack, 6" Stroke, Blackjack Pro Series	1
14415	20 Ton Locking Jack Stand, Min Hgt: 26.18"	2
14462	Titan 36"x36"x2.5" Jack Plate with Non-Skid Surface	1
14465	Titan 12"x12"x1.5" Jack Plate with Non-Skid Surface	4
14466	Titan 18"x12"x3" Jack Plate with Non-Skid Surface	2
14468LT	Titan 24"x24"x2" Jack Plate with Non-Skid Surface, Interlocking	2
15002	Steel Cribbing Set, Includes 3", 6", and 9"	1
15260	12 Piece SuperStacker™ Cribbing Set (15230)	1
16070	Caterpillar Shur-Lok Rim Adapter Kit	1
16200	Conversion Kit for Combi Bead Breaker, Yellow	1
24862	OTR Whip Hose 20', 1/2" Ball Valve with Dial Gauge	1
67300	Nut Buddy	1
91000	Locking Tire Sling	1
92000	2 Point Push Bar 25" - 51" with Steel Push Arms	1
92200	OTR O-Ring Installer Tool up to 30" Rims	1
93000	Flange Ring Puller	1
15035C	5 Quart Air Hydraulic Pump Turbo II with Hose and Coupler	1
TG35	Fiberglass Handle 18", 6 lbs, Rubber Face / Steel Face	1
11002	Italian Mini Combi Aluminum	1
TM25	25' Tape Measure	1
51456	8 lb Soft Face Hammer, Orange	1
75005	Wedges, 7 ^{1/2} ", Lime Green	4
31714	Aluminum Cabled Bead Holder	1
T47	C Bar Kit	1
T27	Lock Ring Tool, 18"	2
LOTOK	Lock Out Tag Kit	1
15301	Big Black Chock, 11.75"x11.5"x10"	2
11002	Aluminum Mini Bead Breaker	1



SMALL OTR TRUCK PACKAGE



#SOTRTP SMALL OTR TRUCK PACKAGE



SMALL OTR TRUCK PACKAGE



LIST OF COMPONENTS INCLUDED IN THE #SOTRTP

PART NUMBER	DESCRIPTION	QUANTITY INCLUDED
11000	OTR Giant Tire Bead Breaker	1
13000	100 Ton Aluminum Jack, 6" Stroke	1
13010	10 Ton Hydraulic Cylinder, 2 1/8" Stroke	1
13020	10 Ton Hydraulic Cylinder, 4 1/8" Stroke	1
13030	10 Ton Hydraulic Cylinder, 6 1/8" Stroke	1
13060	30 Ton Hydraulic Cylinder, 2" Stroke	1
13121	55 Ton Aluminum Jack, 6" Stroke with New Saddle and Base	1
15920	5 Quart Air Hydraulic Pump with Steel Reservoir	2
16050	10,000 psi (700 bar) High Flow Hose Half Coupler, 3/8" NPT	2
16100	8' (2.5M) Hydraulic Hose, 10,000psi (700 bar), 3/8" NPT	2
93000	Flange Ring Puller	2
3110	1" DR 10 PC Socket Set	1
CH-350-LO	Dual Foot Lock On Air Chuck	1
CP-7733-2	Impact 1/2" with 2" Anvil	1
CP-7782-6	CP-7782-6 Wrench, C/P 1" Impact	1
CP-873	Lo-Speed Tire Buffer	1
GA-1555-RCL	Dual Foot Truck Service Gauge	1
GA-255	Large Bore Swivel Gauge	1
H-4660A	Air Chuck	1
T19	T19 24" Tire Iron	1
T21R	Drop Center Tire Tool	2
T23A	Truck Lock Ring Removal Tool	2
T25	T25 18" Rim Tool	1
T26A	T26A Driving Iron	1
T38	30" Tire Iron	1
T41	30" Bead Tool	1
T42	T42 30" Bead Breaker	1
T45A	T45A 37" Tubeless Mount/Demount Bar	2
T48A	Lock Ring Replacing Tool	2
T52	T52 Bead Breaker Leverage Bar	2
TC-370	Quick Connect Hydraulic Coupler, Complete Set	2
TG11E	TG11E Tire Hammer	1
324	L.B Dual Ft. Right Angle Chuck	1
377	Large Bore Hang-On Air Chuck	1
2651	1/2" Square Drive Socket Set, 13pc Deep	1
LBTK	Large Bore Valve Repair Tool	1
5303	1" Female x 3/4" Male Adapter	1
895	50' Length of 1/2" Air Hose	1
84H-8	84H-8 T37 - 8lb. Sledge Hammer	1
ASP10	Large Bore Aspirator	1
CH-315	Small Bore, Clip-on Air Chuck	1
D17	1/2" Quick Coupler, Female	2
DOF	1/2" Adapter, Male 3/8"	4
GA125	Air Water Gauge, Chloride and Air	1
GA250	Large Bore Push-on Gauge	1
T39	30" Single-End Curved Tire Spoon, 7/8" Stock	1
T35	Hammer-Wood Handle	1
TG11EH	TG11EH Tire Hammer Handle	1
15012	3" Steel Crib Stand	1
15022	6" Steel Crib Stand	1
15032	9" Steel Crib Stand	1
15210	Super Stacker Cribbing Block, 4"X4"x18" Black	3
15230	Super Stacker Cribbing Block, 6"X7"x24" Black	12
15301	Big Black Chock, 11.75"x11.5"x10"	2
51456	8 lb Soft Face Hammer, Orange	1
75005	Wedges, 7 1/2", Lime Green	4
14465	Titan 12"x12"x1.5" Jack Plate with Non-Skid Surface	1
364F	364F Reducer, 3/8 x 1/4" Brass	2
94010	Tire Bead Hook, Heavy Duty, 16 lbs	1



LARGE OTR TRUCK PACKAGE



#LOTRTP LARGE OTR TRUCK PACKAGE

TOOL TIP: OTR Wheel Chocks to fit your specific equipment available. Contact us for details!



LARGE OTR TRUCK PACKAGE



LIST OF COMPONENTS INCLUDED IN THE #LOTRTP

PART NUMBER	DESCRIPTION	QUANTITY INCLUDED
11000	OTR Giant Tire Bead Breaker	1
13000	100 Ton Aluminum Jack, 6" Stroke	1
13010	10 Ton Hydraulic Cylinder, 2 ¹ / ₈ " Stroke	1
13020	10 Ton Hydraulic Cylinder, 4 ¹ / ₈ " Stroke	1
13030	10 Ton Hydraulic Cylinder, 6 ¹ / ₈ " Stroke	1
13060	30 Ton Hydraulic Cylinder, 2" Stroke	1
13121	55 Ton Aluminum Jack, 6" Stroke with New Saddle and Base, Blackjack Pro Series	1
15920	5 Quart Air Hydraulic Pump with Steel Reservoir	2
16050	10,000 psi (700 bar) High Flow Hose Half Coupler, 3/8" NPT	2
16100	8' (2.5 meter) Hydraulic Hose, 10,000 psi (700 bar), 3/8" NPT	2
93000	Flange Ring Puller	1
3110	1" DR 10 PC Socket Set	1
CH-350-LO	Dual Foot Lock On Air Chuck	1
CP-7733-2	Impact 1/2" DR with 2" Anvil	1
CP-7782-6	CP-7782-6 Wrench, C/P 1" Impact	1
CP-873	Lo-Speed Tire Buffer	1
GA-155S-RCL	Dual Foot Truck Service Gauge	1
GA-255	Large Bore Swivel Gauge	1
H-4660A	Air Chuck	1
T19	T19 24" Tire Iron	1
T21R	Drop Center Tire Tool	2
T23A	Truck Lock Ring Removal Tool	2
T25	T25 18" Rim Tool	1
T26A	T26A Driving Iron	1
T38	30" Tire Iron	1
T41	30" Bead Tool	1
T42	T42 30" Bead Breaker	1
T45A	T45A 37" Tubeless Mount/Demount Bar	2
T48A	Lock Ring Replacing Tool	2
T52	T52 Bead Breaker Leverage Bar	2
TC-370	Quick Connect Hydraulic Coupler, Complete Set	2
TG11E	TG11E Tire Hammer	1
N-1810	LB Hex Cap Remover	1
N1410	Tire Tread Depth Guage	1
TL690	LB Core Tool	1
IN-95	Inflator Adapter	1
N-1710	LB Core Tool	1
11900	Bead Seat Band Installer	1
11044	OTR Giant Tire Bead Breaker Head with Universal Jaws Kit	1
15230	Super Stacker Cribbing Block, 6" x 7" x 24" Black	12
14468LT	Titan 24" x 24" x 2" Jack Plate with Non-Skid, Interlocking	1
895	50' Length of 1/2" Air Hose	1
5303	1" Female x 3/4" Male Adapter	1
94010	Tire Bead Hook, Heavy Duty, 16k lbs.	1
84H-8	84H-8 T37 8 lb. Sledge Hammer	1
GA-255S-RCL	Large Bore Swivel Recalibratable	1
ASP10	Large Bore Aspirator	1
CH-315	Small Bore, Clip-on Air Chuck	1
D17	1/2" Quick Coupler, Female	2
DOF	1/2" Adapter, Male 3/8"	4
GA125	Air Water Gauge, Chloride and Air	1
GA250	Large Bore Push-on Guage	1
T39	30" Single-End Curved Tire Spoon, 7/8" Stock	1
T35	T35 Hammer-Wood Handle	1
TG11EH	TG11EH Tire Hammer Handle	1
T20A	T20A 30" Tire Iron	2
15012	3" Steel Crib Stand, Small	1
15022	6" Steel Crib Stand, Medium	1
15032	9" Steel Crib Stand, Large	1
324	L.B Dual Ft. Right Angle Chuck	1
377	Large Bore Hang-On Air Chuck	1
364F	364F Reducer, 3/8" x 1/4" Brass	2
LBTK	Large Bore Valve Repair Tool	1
2651	1/2" Square Drive Socket Set, 13 pc. Deep	1
51456	8 lb Soft Face Hammer, Orange	1
75005	Wedges, 7 ¹ / ₂ ", Lime Green	4



TOOL TALK: HYDRAULIC RAMS



HYDRAULIC RAMS

Hydraulic rams are essential to earthmover tire changing. Sometimes referred to as cylinders or 'porta powers' these tools are hydraulically operated and act as a bead breaker on the **backside of 5 piece wheel assemblies**. As 5 piece wheels have limited places where a bead breaker can be 'hooked' to the wheel, a hydraulic ram offers flexibility as to where the rear flange can be pushed back, by placing it against the frame of the vehicle. Various lengths provide flexibility making these rams a necessity on service trucks. 10 ton models have been the standard capacity, but some companies find that 20 ton aluminum rams provide enough power to get the job done all the time. When ordering rams, be sure to know the difference between stroke length and retracted height. A '6 inch ram' can talk about the total length of the cylinder or the amount of piston stroke which extends from the cylinder. The stroke length (also known as the amount of travel), will always be less than the retracted length of the ram.

HYDRAULIC RAMS CAN BE USED TO BREAK THE BEAD ON THE BACKSIDE OF THE FOLLOWING TIRES:

This is not a complete list

23.5R25	33.5-33	37.5R39	33.00R51
26.5R25	36/65-33	40.5/75R39	36.00-51
750/65R25	35/65R33	40/65-39	36.00R51
29.5R25	37.5-33	41.25/70-39	50/65-51
26.5-29	875/65R33	45/65R39	37.00R57
29.5-29	21.00-35	1150/65R45	40.00R57
29.5R29	21.00R35	45/65-45	46/90R57
30/65-29	24.00-35	45/65R45	50/80-57
33.25-29	24.00R35	21.00-49	52/80-57
33.25R29	29.5-35	24.00-49	55/80R63
775/65R29	33.25-35	24.00R49	58/80R63
800/65R29	33.25R35	27.00-49	59/80R63
875/65R29	37.25-35	27.00R49	
18.00-33	37.25R35	30.00-51	
18.00R33	1150/65R39	30.00R51	
21.00R33	37.5-39	33.00-51	

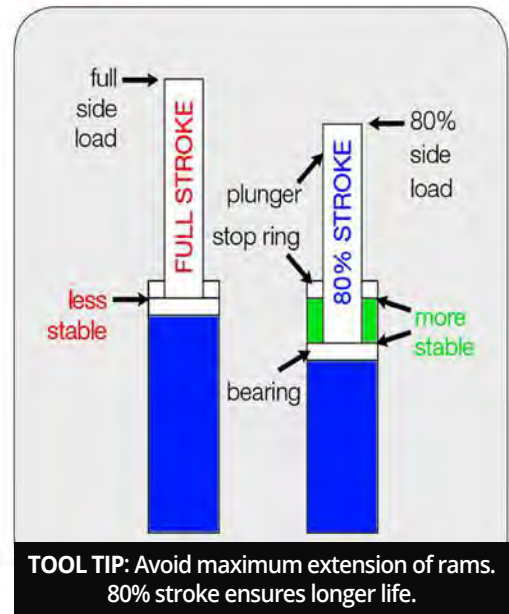

13010-13100 HYDRAULIC RAMS

- Used to break rear beads on 5 piece wheels
- Removable plunger adapter allows the use of a variety of threaded attachments
- A must have for OTR wheel and tire service

Model	Capacity	Stroke	Retracted Height
13010	10 Ton	2 -1/8" (5.4 cm)	4-3/4" (12.1 cm)
13020	10 Ton	4" (10.5 cm)	6-3/4" (17.14cm)
13030	10 Ton	6-1/8" (15.57 cm)	9-3/4" (24.77 cm)
13040	10 Ton	8" (20.32 cm)	11-3/4" (29.84 cm)
13050	10 Ton	10-1/8" (25.73 cm)	13- 3/4" (35 cm)
13060	30 Ton	2-7/16" (6.19 cm)	4- 5/8" (11.75 cm)
13090	25 Ton	8-1/4" (21 cm)	12-3/4" (32.39 cm)
13095	25 Ton	10-1/8" (25.73 cm)	14-3/4" (37.4 cm)
13100	25 Ton	6-1/4" (15.75 cm)	10-3/4" (27.3 cm)



13075 STEEL-A-STACK HYDRAULIC RAM KIT

- Versatile ram kit allows you to select your ram length from 3.5" (9 cm) up to 11.5" (29.21 cm)
- Extensions can be used individually or together
- Steel extensions are durable enough for OTR applications
- Extensions include 1" (2.5 cm), 2" (5 cm), and 3" (7.5 cm) options
- 3" extension includes a screw-in saddle that extends another 2"
- Ships in HD carrying case
- 10 Ton 1.5" (3.8 cm) stroke
- Weight: 11 lbs (5 kg)



13076 STEEL-A-STACK COMPLETE KIT

- Versatile ram kit allows you to select your ram length from 3.5" (9 cm) up to 11.5" (29.21 cm)
- Steel extensions are durable enough for OTR applications
- Extensions can be used individually or together
- Extensions include 1" (2.5 cm), 2" (5 cm), and 3" (7.5 cm) options
- 3" extension includes a screw-in saddle that extends another 2"
- Ships in HD carrying case
- 10 Ton 1.5" (3.8 cm) stroke
- Includes hydraulic hand pump





TOOL TALK: AIR/HYDRAULIC PUMPS



USING AIR/HYDRAULIC PUMPS WITH BEAD BREAKERS AND LIFTING CYLINDERS

We are often asked which pumps will work with which tools. To help alleviate confusion, below is a Usage vs Supply chart. All AME pumps generate 10,000 psi of hydraulic pressure and all AME bead breakers and rams have a maximum working load rating when 10,000 psi is applied. For example, a 10-ton ram exerts 10 tons of force when 10,000 psi of hydraulic pressure is supplied. Larger pumps (5 qt. or 2 gallon) exert the same 10,000 psi hydraulic pressure but hold more oil. More oil is sometimes necessary on larger 100-ton or 150-ton rams, as they have a large volume of space in the cylinder to be filled to reach the maximum height.

Hydraulic Pump HYDRAULIC OIL AVAILABLE		Bead Breaker/Ram HYDRAULIC OIL NEEDED				Oil Required to Fill A NEW HYDRAULIC HOSE	
Model	CU/IN.	Model	CU/IN.	Model	CU/IN.	Model	CU/IN.
15000	127	11000	10	13060	4	16100	11
15010	116	11010	20	13070	4	16105	14
15020	230	11020	20	13081	68	16110	25
15025	289	11030	33	13090	43	16116	8
15030	219	11040	23	13100	33	16120	17
15035	278	11050	5	13120	71		
15040	450	11060	30	13121	71		
15050	439	11075	25	13140	115		
15900	105	11080	6	13141	115		
15905	144	11090	20	13154	74		
15910	94	13000	129	13155	135		
15920	185	13010	5	13156	210		
15930	174	13020	10	13160	210		
15940	570	13030	14				
15950	559	13040	20				
15075	134	13050	23				
15080	40						



15905

2.5 QUART TITAN AIR/HYDRAULIC PUMP (10,000 PSI)

- Builds 10,000 PSI (700 Bar) hydraulic pressure (max pressure)
- Operates with as little as 80 PSI (5.5 bar)
- Heavy duty steel reservoir
- Durable metal air motor
- Weight: 18 lbs (8.2 kg)



15906

2.5 QUART TITAN AIR/HYDRAULIC PUMP (5,500 PSI)

- Builds 5,500 PSI (379 Bar) hydraulic pressure (max pressure)
- Operates with as little as 80 PSI (5.5 bar)
- High density polyethylene reservoir
- Durable metal air motor
- Weight: 18 lbs (8.2 kg)



15907

2.5 QUART TITAN AIR/HYDRAULIC PUMP (3,900 PSI)

- Builds 3,900 PSI (269 Bar) hydraulic pressure (max pressure)
- Operates with as little as 80 PSI (5.5 bar)
- High density polyethylene reservoir
- Durable metal air motor
- Weight: 18 lbs (8.2 kg)



15924

5 QUART TITAN AIR/HYDRAULIC PUMP (STEEL RESERVOIR)

- Builds 10,000 PSI (700 Bar) hydraulic pressure (max pressure)
- Operates with as little as 80 PSI (5.5 bar)
- Ideal for use with tools that require large volume of oil (55, 100 ton cylinders)
- Heavy duty steel reservoir
- Durable metal air motor
- Weight: 23 lbs (10.4 kg)



15925

5 QUART TITAN AIR/HYDRAULIC PUMP (POLYETHYLENE RESERVOIR)

- Builds 10,000 PSI (700 Bar) hydraulic pressure (max pressure)
- Operates with as little as 80 PSI (5.5 bar)
- Ideal for use with tools that require large volume of oil (55, 100 ton cylinders)
- High density polyethylene reservoir
- Durable metal air motor
- Weight: 20 lbs (9.1 kg)





AIR/HYDRAULIC PUMPS



15000

3.5 QUART AIR/HYDRAULIC PUMP WITH POLYGLASS RESERVOIR

- Builds 10,000 PSI (max) of pressure to fit the majority of tools on the market
- Operates on 80-120 PSI of inlet air pressure (Standard on most compressors and shop air)
- Durable metal air motor assemblies
- Designed specific for conditions normally associated with OTR sites
- Turbo II includes air motor oil level sight glass
- Weight: 16 lbs (7.3 kg)



15020

5 QUART AIR/HYDRAULIC PUMP WITH POLYGLASS RESERVOIR

- Builds 10,000 PSI (max) of pressure to fit the majority of tools on the market
- Operates on 80-120 PSI of inlet air pressure (Standard on most compressors and shop air)
- Durable metal air motor assemblies
- Designed specific for conditions normally associated with OTR sites
- Turbo II includes air motor oil level sight glass
- Weight: 23 lbs (10.4 kg)



15025

5 QUART AIR/HYDRAULIC PUMP, STEEL

- Builds 10,000 PSI (max) of pressure to fit the majority of tools on the market
- Operates on 80-120 PSI of inlet air pressure (Standard on most compressors and shop air)
- Durable metal air motor assemblies
- Designed specific for conditions normally associated with OTR sites
- Turbo II includes air motor oil level sight glass
- Weight: 30 lbs (13.6 kg)



15040

2 GALLON AIR/HYDRAULIC PUMP, STEEL

- Builds 10,000 PSI (max) of pressure to fit the majority of tools on the market
- Operates on 80-120 PSI of inlet air pressure (Standard on most compressors and shop air)
- Durable metal air motor assemblies
- Designed specific for conditions normally associated with OTR sites
- Turbo II includes air motor oil level sight glass
- Weight: 41 lbs (18.6 kg)

15900

2.5 QUART TITAN AIR/HYDRAULIC PUMP, POLYETHYLENE

- Builds 10,000 PSI (max) of pressure to fit the majority of tools on the market
- Operates on 80-120 PSI of inlet air pressure (Standard on most compressors and shop air)
- Durable metal air motor assemblies
- Designed specific for conditions normally associated with OTR sites
- Weight: 14 lbs (6.4 kg)



15921

5 QUART AIR/HYDRAULIC PUMP, PLASTIC

- Builds 10,000 PSI (max) of pressure to fit the majority of tools on the market
- Operates on 80-120 PSI of inlet air pressure (Standard on most compressors and shop air)
- Durable metal air motor assemblies
- Designed specific for conditions normally associated with OTR sites
- Weight: 19 lbs (8.7 kg)



15920

5 QUART AIR/HYDRAULIC PUMP, STEEL

- Builds 10,000 PSI (max) of pressure to fit the majority of tools on the market
- Operates on 80-120 PSI of inlet air pressure (Standard on most compressors and shop air)
- Durable metal air motor assemblies
- Designed specific for conditions normally associated with OTR sites
- Weight: 23 lbs (10.4 kg)
- #15930C comes with hose and coupler



15940

2 GALLON AIR/HYDRAULIC PUMP, STEEL

- Builds 10,000 PSI (max) of pressure to fit the majority of tools on the market
- Operates on 80-120 PSI of inlet air pressure (Standard on most compressors and shop air)
- Durable metal air motor assemblies
- Designed specific for conditions normally associated with OTR sites
- Weight: 36 lbs (16.32 kg)



15901

MILLER MUD FLAP

TOOL TIP: Inexpensive preventative maintenance solution for your hydraulic pump.

- Fits AME model #15920 and IMT style pumps
- Prevents dirt from contaminating the release valve
- Inexpensive solution to improve the service life of your pump



*Pump not included



AIR/HYDRAULIC PUMPS & ACCESSORIES



15001 HIGH FLOW AIR HYDRAULIC PUMP

- Higher oil flow for increased productivity
- Closed Hydraulic system prevents contamination
- "Bladder" system prevents loss of prime and limits on usage
- Locking function for retraction
- Weight: 24 lbs (11 kg)



15081 HYDRAULIC HAND PUMP

- 10,000 psi (700 bar) Maximum operating pressure
- Low cost alternative to air hydraulic pumps
- Weight: 19 lbs (8.7 kg)



16016-16160 HYDRAULIC HOSES

- 10,000 psi (700 bar) working pressure hydraulic hose
- Equipped with 3/8" NPT ends, including one swivel end
- Meets IJ100 jack hose specification



Hose Length	No Coupler	Hi Flow Male (16050)	Complete Hi Flow (16000)	Quick Connect Female (TC-371)	Complete Coupler (TC-370)
6'	16116	16016	16160	16116-TC	16160-TC
8'	16100	16040	16030	16100-TC	16030-TC
10'	16105	16045	16035	16105-TC	16035-TC
12'	16120	16010	16025	16120-TC	16025-TC
18'	16110	16015	16020	16110-TC	16020-TC

Custom sizes available



16000 HIGH FLOW HYDRAULIC COUPLERS

- Model #16000 - Complete Set (#16050 - Male Half, #16060 - Female Half)
- Interchange with Enerpac C604 and Power Team/OTC 9795
- Plastic dust cover available (Model #CD-411)



TC-370A QUICK CONNECT HYDRAULIC COUPLERS

- 10,000 PSI (700 bar) quick connect coupling, 3/8" NPT
- Parker Series couplings (interchange with IMT couplings)
- Model #TC-370 - Complete Set (#TC-371 - Female Half, #TC-372 - Male Half)



AME INTERNATIONAL ALUMINUM JACKS

ALUMINUM JACKS

Aluminum jacks are popular among tire dealers due to their weight. In many cases, these jacks may be as much as half the weight of their steel counterparts. 55 Ton jacks were the first generation of jacks, although as vehicles have gotten larger and capacities increased, more dealers are opting for 75 or 100 Ton jacks.

ALUMINUM VS. STEEL

The aluminum that is used in hydraulic jacks is designed for high pressure. Similar to the makeup of material used in aerospace, the aluminum offers high strength with light weight. Aluminum jacks offer longevity and durability like their steel counterparts.

LOCKING COLLARS

A unique feature available with aluminum cylinders is the ability to include a locking cylinder on the jack. This device allows for the mechanical locking of the cylinder, so the unit can safely be used not only to lift the load, but also to support the load. It is important to know that without the use of a locking collar that jacks should be used only to lift the load. When lifting only with jacks, a load should then be lowered onto stands or cribbing in order to comply with OSHA regulation 29CFR1926.305.





ALUMINUM JACKS



13081 55 TON ALUMINUM JACK, DELUXE

- Includes "Shut-Off Valve" to allow the pump to be removed while ram is extended (also included on #13005 & #13000)
- Aluminum base plate for stability during field use
- Extra thick aluminum cylinder walls measure .80" (2 cm) for heavy duty use
- Advanced piston coating resists scarring for longer life
- New stop ring design specifically for tire industry
- Reduces side load damage
- Stroke: 6" (15cm)
- Retracted height: 12.25" (31.12 cm)
- Weight: 24.5 lbs (11.1 kg)



New DUO-RING™ System



13005 75 TON BLACKJACK SERIES ALUMINUM JACK

- Includes "Shut-Off Valve" to allow the pump to be removed while ram is extended
- Stroke: 6" (15 cm) Stroke
- Retracted height: 12" (30.5 cm)
- Maximum height: 18" (48 cm)
- Weight: 38 lbs (17 kg)



13000 100 TON BLACKJACK SERIES ALUMINUM JACK

- Includes "Shut-Off Valve" to allow the pump to be removed while ram is extended
- Stroke: 6" (15 cm) Stroke
- Retracted height: 12" (30.5 cm)
- Maximum height: 18" (48 cm)
- Weight: 53 lbs (24 kg)



13120

55 TON HEAVY DUTY SERIES

- Lightweight aluminum for easily handling and placing under the vehicle
- Includes "Shut-Off Valve" which allows the pump to be removed while the ram is extended
- Aluminum base plate included on 55 ton models
- Capacity: 55 tons
- Stroke: 6" (15 cm) stroke
- Retracted height: 12.25" (31 cm)
- Maximum height: 18.25" (46 cm)
- Weight: 29 lbs (13.2 kg)



13121

55 TON PRO SERIES

- Lightweight aluminum for easily handling and placing under the vehicle
- Includes "Shut-Off Valve" which allows the pump to be removed while the ram is extended
- Recessed base plate allows jacks to nest inside
- Low profile saddle ensures precise lifting
- Capacity: 55 tons
- Stroke: 6" (15cm)
- Retracted height: 11.75" (30cm)
- Maximum height: 17.75" (45 cm)
- Weight: 29 lbs (13.2 kg)



13140

55 TON HEAVY DUTY SERIES

- Lightweight aluminum for easily handling and placing under the vehicle
- Includes "Shut-Off Valve" which allows the pump to be removed while the ram is extended
- Capacity: 55 tons
- Stroke: 10" (25 cm)
- Retracted height: 16.25" (41 cm)
- Maximum height: 26.25" (66.5 cm)
- Weight: 38 lbs (17.2 kg)





ALUMINUM JACKS & ACCESSORIES

13154/13155 55/100 TON LOAD LOCK'R ALUMINUM JACKS

- Aluminum lock nut provides mechanical load holding for extended periods
- Composite bearings increase cylinder life and side load resistance
- Equipped with bolt-on hardened steel saddle
- Hard coat finish resists damage and extends cylinder life

Model	Capacity	Stroke	Min. Height	Max. Height	Weight
13154	55 tons	6" (15 cm)	13.2" (33.5 cm)	19.1" (48.5 cm)	26.2 lbs (11.9 kg)
13155	100 tons	6" (15 cm)	15.6" (39.6 cm)	21.5" (54 cm)	58 lbs (26 kg)



13122 SHUT OFF VALVE ASSEMBLY

- Allows pump to be removed while ram is extended
- For use with single acting hydraulic cylinder
- Rated at 10,000PSI (700 BAR)



13121-SBK SBK-SADDLE BASE CONVERSION KIT

- Reduces point loading of the saddle
- Recessed base plate reduces broken bolts.
- No more bent/broken corners.
- More stable lifting platform
- Upgrade your existing 55 ton jack
- Works on models #13120 and #13140



14462-14473 JACK PLATES



- Jack plates provide greater stability to bottle jacks, hydraulic rams, jack stands and cribbing
- Lightweight and easy to handle
- Non-skid surface to prevent jacks from sliding under wet or oily conditions
- Durable high density polymer resists the elements
- Complies with OSHA regulation 29 CFR 1926.305, "When it is necessary to provide a firm foundation, the base of the jack shall be blocked or cribbed."



TOOL TIP:
The new #14468LT Jack Plate interlocks with SuperStacker™ Cribbing blocks (pg. 55), providing a level surface and greater stability.



Model	Length	Width	Height	Capacity (Tons)	Weight
14462	36" (91 cm)	36" (91 cm)	2.5" (6.4 cm)	150	118 lbs (53.5 kg)
14463	36" (91 cm)	36" (91 cm)	3" (7.6 cm)	200	135 lbs (61.2 kg)
14464	12" (30.5 cm)	12" (30.5 cm)	1" (2.54 cm)	50	5 lbs (2.3 kg)
14465	12" (30.5 cm)	12" (30.5 cm)	1.5" (3.81 cm)	100	8 lbs (3.6 kg)
14466	18" (45.7 cm)	12" (30.5 cm)	3" (7.62 cm)	200	21 lbs (9.5 kg)
14468	24" (61 cm)	24" (61 cm)	2" (5.08 cm)	100	24 lbs (10.9 kg)
14468LT	24" (61 cm)	24" (61 cm)	2" (5.08 cm)	100	24 lbs (10.9 kg)
14469	18" (45.7 cm)	18" (45.7 cm)	2" (5.08 cm)	100	20 lbs (9.1 kg)
14472	18" (45.7 cm)	18" (45.7 cm)	1" (2.54 cm)	50	15 lbs (6.8 kg)
14473	18" (45.7 cm)	18" (45.7 cm)	1.5" (3.81 cm)	100	16 lbs (7.3 kg)

PTW-SERIES PNEUMATIC TORQUE WRENCHES

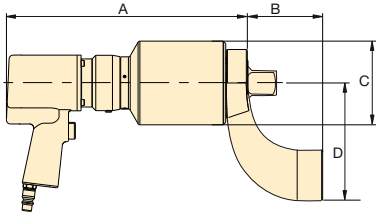

▼ SELECTION CHART

Minimum Torque		Maximum Torque		Square Drive (in)	Model Number*	RPM	Dimensions (in)				Weight** (lbs)
(ft-lbs)	(Nm)	(ft-lbs)	(Nm)				A	B	C	D	
300	407	1000	1356	1	PTW1000C	12.6	10.70	3.27	2.83	5.12	18
500	678	2000	2712	1	PTW2000C	8.0	11.26	3.27	3.11	5.24	19.5
900	1220	3000	4067	1	PTW3000C	3.1	13.50	3.27	3.74	5.24	23
1300	1763	6000	8135	1½	PTW6000C	2.5	14.40	4.49	5.00	7.00	39

* To order without FRL and hose, remove "C" Suffix (e.g. PTW3000).

All tools are shipped complete with standard reaction arm and FRL. ** Weight does not include reaction arm. Reaction arm weight for PTW1000, PTW2000, PTW3000 is 2.9 lbs. and PTW6000 is 7.75 lbs.

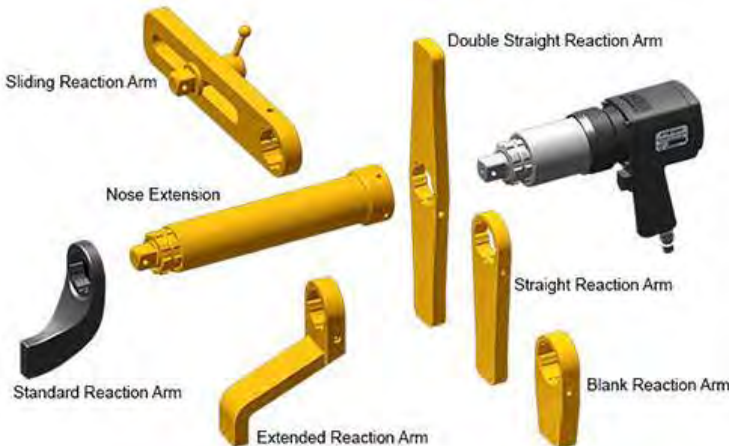

Optional Accessories

For use with PTW1000, PTW2000, PTW3000-models

Nr.	Description	Model Nr.	Application
1	Standard Reaction Arm	RATWS	Standard arm included with PTW-model
2	Extended Drive 6 inch	ED6TWS	Nose extension, primarily for truck wheel bolts
2	Extended Drive 12 inch	ED12TWS	Nose extension, primarily for truck wheel bolts
2	Extended Drive 18 inch	ED18TWS	Nose extension, primarily for truck wheel bolts
3	Sliding Reaction Arm	SLRATWS	For widely spaced and uneven bolt centers
4	Double Straight Arm	DSATWS	Reduces time to reposition arm *
5	Extended Reaction Arm	ERATWS	Long plate for use with deep well sockets
6	Blank Reaction Arm	BLTWS	Weldable blank for custom applications **
7	Straight Reaction Arm	SRATWS	Long plate for wide spaced reaction points

For use with PTW6000-model

Nr.	Description	Model Nr.	Application
1	Standard Reaction Arm	RATWL	Standard arm included with PTW-model
2	Extended Drive 6 inch	ED6TWL	152 mm nose extension, primarily for truck wheel bolts
2	Extended Drive 12 inch	ED12TWL	305 mm nose extension, primarily for truck wheel bolts
3	Sliding Reaction Arm	SLRATWL	For widely spaced and uneven bolt centers
4	Double Straight Arm	DSATWL	Reduces time to reposition arm *
5	Extended Reaction Arm	ERATWL	Long plate for use with deep well sockets
6	Blank Reaction Arm	BLTWL	Weldable blank for custom applications **
7	Straight Reaction Arm	SRATWL	Long plate for wide spaced reaction points

* Time to reposition arm when repeatedly moving from tightening to loosening.

** Blank reaction arms must be heat treated to HRC 38-42 prior to use.



MINING JACKS: INTRODUCTION



MINING JACKS: INTRODUCTION

TOOL TALK

High capacity mobile jacks are often called mining jacks. Our line of mining jacks are designed for high volume use on a wide range of OTR equipment. Ruggedized for mining, our line of products will help you lift the heaviest equipment in your fleet safely and efficiently.

RELIABILITY

Drawing on years of industry knowledge and best practices, our jacks are constructed to the highest standards. We pride ourselves on being the quality leader when it comes to lifting your equipment. We back these claims with award winning customer service and warranties.

SAFETY

AME International keeps the highest standard of safety with our line of mining jacks. Our products are designed with the user in mind. The operator can emplace and use our jacks without getting under the load. We feature hydraulic safety valves and offer load support ranging from stands to locking collars.

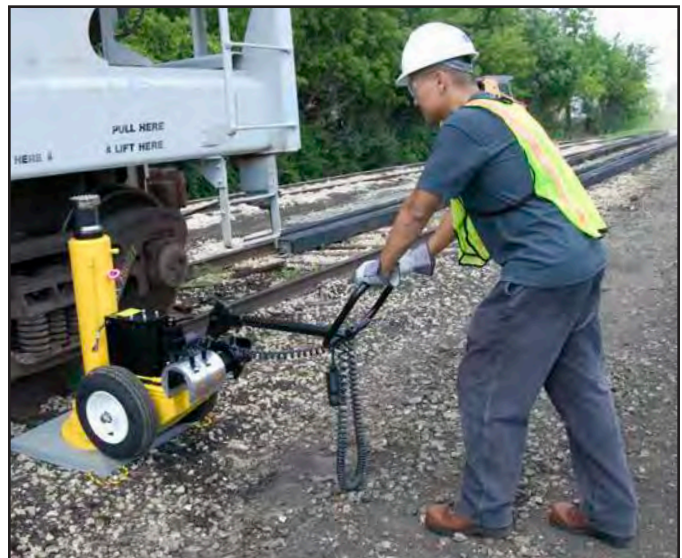



RHINO JACK II

Specifically designed for the mining industry, the Rhino II 100, 150, 200 ton heavy-duty hydraulic jacks are the result of modern technology and are your best bet when servicing and maintaining large off-road vehicles and equipment. Trouble free and safe, they operate on the universally accepted electric/hydraulic or air/hydraulic systems. The Rhino II jack lifts from the lowest lift point of your vehicle. If necessary, the cylinder extension will give you ample elevation to raise your vehicle from its highest point.

The total lifting procedure involves only one operator and can lift a large mining vehicle in minutes. Rhino II Jacks are fitted with 5.30x12 tires on tapered roller bearings so that accurate positioning can be achieved quickly and safely. The jack will operate from the standard 90 - 160 psi shop air supply. Electric jacks can be suited to meet your power requirements. All Rhino II Jacks are built with mobility and transportability in mind.

Model	Stroke	Capacity (Tons)	Min. Height	Max. Height	Weight
RJ2-10027	15.5" (39.37 cm)	100	27" (69 cm)	42.5" (107.95 cm)	617 lbs (279.87 kg)
RJ2-10038	26.13" (66.37 cm)	100	38" (96.5 cm)	64.13" (163 cm)	736 lbs (333.84 kg)
RJ2-15027	14.75" (37.47 cm)	150	27" (69 cm)	42" (106.68 cm)	720 lbs (326.59 kg)
RJ2-15038	25.38" (64.47 cm)	150	38" (96.5 cm)	63.38" (161 cm)	899 lbs (407.78 kg)
RJ2-20027	14" (35.56 cm)	200	27" (69 cm)	42" (106.68 cm)	826 lbs (374.67 kg)
RJ2-20038	24.5" (62.23 cm)	200	38" (96.5 cm)	62.5" (158.75 cm)	1059 lbs (480.35 kg)





POW'R-RISER II® LIFTING JACKS



POW'R-RISER II® LIFTING JACKS

60, 100, 150 and 200-ton capacities with pneumatic or electric pumps for the toughest jobs. 4" ground clearance for transport over rail and rough terrain. Three position handle provides easy tilt back and transport. Complies with ASME/ANSI B30.1 specifications. Easy-to-change external filter minimizes down time. Rugged, fully enclosed 24" wide frame with no exposed fittings or hoses. SUP-R-STACK™ Extension System allows lifting at all heights without blocking.

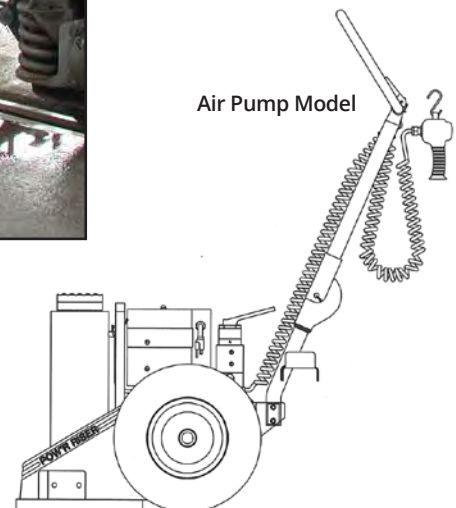
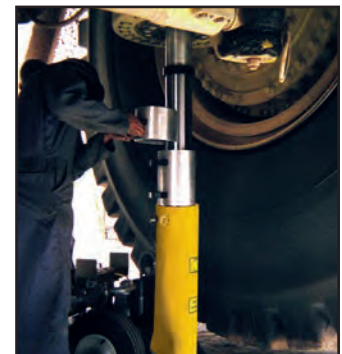

POW'R-RISER II® ACCESSORIES

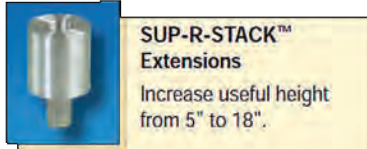

SUP-R-STACK™ Extensions
Increase useful height from 5" to 18".

Model No.	Size (in)	Model No.	Size (in)
PRE5	5	PRE11	11
PRE7	7	PRE14	14
PRE9	9	PRE18	18
PRES6024	Extension set includes PRE5, PRE7, PRE11 and PRE18		



Spacers

Fine tune your Extension stack height.

Model No.	Size (in)	Model No.	Size (in)
PRS1	1	PRS3	3
PRS2	2	-	-
PRS4	Set includes (2) PRS1, (1) PRS2 and (1) PRS3		

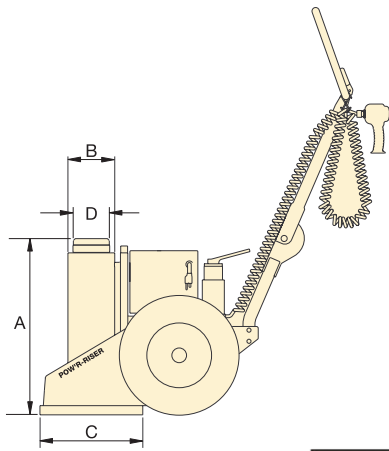

Cap. (ton)	Swivel Load Cap	Locking U-Rings					Set Model Number	Locking U-Ring Sets Include
		1 in.	3 in.	4½ in.	5½ in.	10 in.		
60	PRTS60	PRU11	PRU13	PRU14	-	PRU110	¹ PRUS126	(2) PRU11, (1) PRU13, (2) PRU14
							² PRUS137	(2) PRU11, (1) PRU13, (2) PRU14 (1) PRU110
100	PRTS60	PRU11	PRU13	PRU14	-	PRU110	¹ PRUS126	(2) PRU11, (1) PRU13, (2) PRU14
							² PRUS137	(2) PRU11, (1) PRU13, (2) PRU14 (1) PRU110
150	PRTS150	PRU151	PRU153	-	PRU155	PRU1510	³ PRUS1526	(2) PRU151, (1) PRU153, (2) PRU155
							² PRUS1537	(2) PRU151, (1) PRU1510, (2) PRU155
200	PRTS200	PRU201	PRU203	-	PRU205	PRU2010	³ PRUS2026	(2) PRU201, (1) PRU203, (2) PRU205
							² PRUS2037	(2) PRU201, (1) PRU2010, (2) PRU205

- 1) For 14 and 16" stroke models
2) For 27" stroke models 3) For 15.5 stroke models

*Based on one 18" and one 11" Extension and one 3" Spacer.

**Based on one 18" Extension and one 3" Spacer.

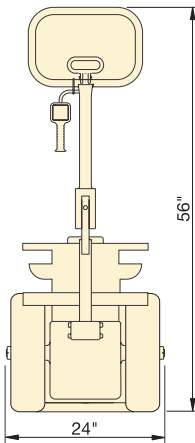

Capacity (ton)	Stroke (in)	Air Pump	Weight (lbs)	A	B	C	D	Valve Type
60	14	PRAMA06014L	390	24	6.4	14	4	Manual
	27	PRAMA06027L	600	37	6.4	14	4	
100	16	PRAMA10016L	510	26	7.0	18	4	Pneumatic
	27	PRAMA10027L	600	37	7.0	18	4	
	16	PRASA10016L	510	26	7.0	18	4	
	27	PRASA10027L	600	37	7.0	18	4	
150	15.5	PRASA15016L	570	26	8.0	18	5	Manual
	26.5	PRASA15027L	708	37	8.0	18	5	
	15.5	-	-	26	8.0	18	5	
	26.5	-	-	37	8.0	18	5	
200	15.5	PRASA20016L	640	26	9.5	18	6	Pneumatic
	26.5	PRASA20027L	825	37	9.5	18	6	

Also Key For Valve Type



SUPERLIFT JACKS



SUPERLIFT JACKS

Air/Hydraulic Mining Jacks from 100 – 250 Ton. Each jack comes with custom extensions based on your specific application. Electric power unit available. Optional Power Drive System available on jacks 150 Ton and larger. Power Drive System self propels SLJ Jack over terrain with no effort from operator.



Model	Capacity (Tons)	Min. Height	Max. Height	Total Width	Frame Length	Handle Height	Cylinder Base	Weight
SLJ10027	100	27" (69 cm)	43" (109 cm)	29" (74 cm)	96" (244 cm)	40" (101 cm)	13" (33 cm)	771 lbs (350 kg)
SLJ10038	100	38" (97 cm)	65" (165 cm)	29" (74 cm)	96" (244 cm)	40" (101 cm)	13" (33 cm)	851 lbs (386 kg)
SLJ15027	150	27" (69 cm)	43" (109 cm)	29" (74 cm)	96" (244 cm)	40" (101 cm)	15" (38 cm)	794 lbs (360 kg)
SLJ15038	150	38" (97 cm)	65" (165 cm)	29" (74 cm)	96" (244 cm)	40" (101 cm)	15" (38 cm)	905 lbs (410 kg)
SLJ20027	200	27" (69 cm)	43" (109 cm)	32" (82 cm)	96" (244 cm)	40" (101 cm)	15" (38 cm)	1243 lbs (564 kg)
SLJ20038	200	38" (97 cm)	65" (165 cm)	32" (82 cm)	96" (244 cm)	40" (101 cm)	15" (38 cm)	1345 lbs (610 kg)
SLJ25027	250	27" (69 cm)	43" (109 cm)	32" (82 cm)	96" (244 cm)	40" (101 cm)	15" (38 cm)	1415 lbs (640 kg)
SLJ25038	250	38" (97 cm)	65" (165 cm)	32" (82 cm)	96" (244 cm)	40" (101 cm)	15" (38 cm)	1555 lbs (705 kg)



EXTENSION CHART FOR SUPERLIFT JACKS, RHINO II JACKS, & EQUIPMENT SUPPORT SYSTEMS

JACK / STAND CAPACITY

EXTENSION HEIGHT	JACK CAPACITY	40/60 tons	80 tons	100 tons	150 tons	200 tons
	STAND CAPACITY		100/150 tons	200/250 tons	300/350 tons	
6"		SLJE506	SLJE606	SLJE706	SLJE806	SLJE906
8"		SLJE508	SLJE608	SLJE708	SLJE808	SLJE908
10"		SLJE510	SLJE610	SLJE710	SLJE810	SLJE910
12"		SLJE512	SLJE612	SLJE712	SLJE812	SLJE912
16"		SLJE516	SLJE616	SLJE716	SLJE816	SLJE916
18"		SLJE518	SLJE618	SLJE718	SLJE818	SLJE918

LOCKING COLLAR SETS



Model	Description
SLJLC150K	Locking Collar Set for SuperLift (100 to 150 Ton). Included are Locking Collars: SLJLC150-1, SLJLC150-2, SLJLC150-3, SLJLC150-6, SLJLC150-AR, SLJLC150-TC
SLJLC350K	Locking Collar Set for SuperLift (200 to 350 Ton). Included are Locking Collars: SLJLC350-1, SLJLC350-2, SLJLC350-3, SLJLC350-4, SLJLC350-AR, SLJLC350-TC



SUPERLIFT JACK STANDS & TRANSPORTERS



SLJS100 SLJS150 SLJS200 SUPERLIFT JACK STANDS



- Custom heights can be determined upon order to meet the customer's needs
- Saddle and custom extension supplied with each stand
- Certificates of conformity supplied for international and domestic requirements

Model	Capacity	Min. Height	Adjustable	Weight
SLJS100	100 tons	24" (60.96 cm)	No	353 lbs (160.12 kg)
SLJS100-28A	100 tons	28" (71.12 cm)	Yes	353 lbs (160.12 kg)
SLJS100-038A	100 tons	38" (96.52 cm)	Yes	353 lbs (160.12 kg)
SLJS150-32A	150 tons	32" (81.28 cm)	Yes	425 lbs (192.78 kg)
SLJS150-42A	150 tons	42" (106.68 cm)	Yes	425 lbs (192.78 kg)
SLJS150-50A	150 tons	50" (127 cm)	Yes	425 lbs (192.78 kg)
SLJS200	200 tons	32" (81.28 cm)	No	639 lbs (289.85 kg)
SLJS200-42	200 tons	42" (106.68 cm)	Yes	639 lbs (289.85 kg)



SLJST100 SLJST150 SLJST200 SUPERLIFT JACK STAND TRANSPORTERS

- Support weight with engineered safety stands
- Meets international safety standards
- Heavy duty steel plate to ensure longevity
- Transporter allows for easy placement

Model	Capacity	Weight
SLJST100	100 tons	154 lbs (69.85 kg)
SLJST150	150 tons	159 lbs (72.12 kg)
SLJST200	200 tons	164 lbs (74.39 kg)



AC HYDRAULIC^{A/S} MINING JACKS



AC Hydraulic^{A/S}
NO COMPROMISE

AC HYDRAULIC^{A/S} MINING JACKS

AME International presents AC Hydraulic^{A/S} heavy duty jacks for low clearance machinery in mining and construction industries. All steel, heavy duty chassis build to fit harsh environments. Large rubber tires allow easy positioning on challenging surfaces. Innovative chassis construction facilitates jack repair and even wheel changing on site. High ground clearance for clearing rail and rough terrain. Multiple position handle for easy tilt back and moving. Handle with dead-man's release for optimum safety during lifting and lowering. Mining jack handle length: 51.2" (130 cm).



Model	Capacity	Min. Height / Max. Height	Total Width	Frame Length	Air Supply	Air Consumption	Ground Clearance	Weight
100-1L	100 tons	17.1" (43.5 cm) / 22.4" (57 cm)	18.3" (46.5 cm)	61" (155 cm)	10 bar	1200 l/min	1.6" (4 cm)	731.9 lbs (332 kg)
150-1L	150 tons	17.1" (43.5 cm) / 22.4" (57 cm)	18.3" (46.5 cm)	61" (155 cm)	10 bar	1200 l/min	1.6" (4 cm)	731.9 lbs (332 kg)
100-1	100 tons	27.6" (70 cm) / 43.3" (110 cm)	27" (68.5 cm)	66" (167.5 cm)	10 bar	1200 l/min	2.6" (6.5 cm)	1049.4 lbs (476 kg)
150-1	150 tons	27.6" (70 cm) / 43.3" (110 cm)	27" (68.5 cm)	66" (167.5 cm)	10 bar	1200 l/min	2.6" (6.5 cm)	1049.4 lbs (476 kg)
100-1H	100 tons	37.4" (95 cm) / 63" (160 cm)	27" (68.5 cm)	66" (167.5 cm)	10 bar	1200 l/min	2.6" (6.5 cm)	1203.7 lbs (546kg)
150-1H	150 tons	37.4" (95 cm) / 63" (160 cm)	27" (68.5 cm)	66" (167.5 cm)	10 bar	1200 l/min	2.6" (6.5 cm)	1203.7 lbs (546kg)

FHD100 / FHD200 Extensions

Increases lifting height by 3.9" (10 cm) / 7.9" (20 cm)



SB65 / SB100 / SB150 Locking Rings

SB65: 6.5 cm

Fits: All models

SB100: 10 cm

Fits: 100-1 / 150-1, 100-1H / 150-1H

SB150: 15 cm

Fits: 100-1 / 150-1, 100-1H / 150-1H



BHD Locking ring holder
Allows for the locking rings to be stored on the jack
(Included in Locking Ring Kit)



HHD Extension Holder
Allows for extensions to be stored on the side of the jack





91000 LOCKING TIRE SLING

- Locking brass rollers allow the tire to be positioned as needed
- Safe, efficient way to handle tires up to 39"
- Rated capacity: 6,500 lbs. (2,950 kg)
- For use with every boom style service truck
- Locking pins allow the tire to be held in any position
- Weight: 50 lbs. (22.7 kg)



93000 FLANGE RING PULLER

- Lifts the rim base and bead seat band from the tire
- Aids in bead seating during inflation
- Attaches to a standard boom style service truck
- 4 point hook/chain assembly for optimal lifting
- Rated capacity: 5,400 lbs. (2,449 kg)
- Chain lengths of 30" (76.2 cm)
- Includes 2 flat hooks and 2 tapered hooks to allow use on ALL rim styles
- Weight: 32 lbs. (14.5 kg)



92000

2 POINT PUSH BAR

- Standard unit fits 25" - 51" multi-piece wheels
- Attaches to the boom crane and depresses the flange ring and bead seat band for efficient mounting of earthmover tires
- For use with every boom style service truck
- Steel arm castings out perform aluminum
- Model 92005 Push Bar works on 33" - 57" wheels
- Replacement steel arm (model #92000-001) can be ordered to replace aluminum castings
- Weight: 65 lbs. (29.5 kg)



92250

OTR LARGE O-RING INSTALLER

- Installs and removes O-Rings on OTR Tires 25"-36"
- Assists in the removal/installation of the lock ring as well

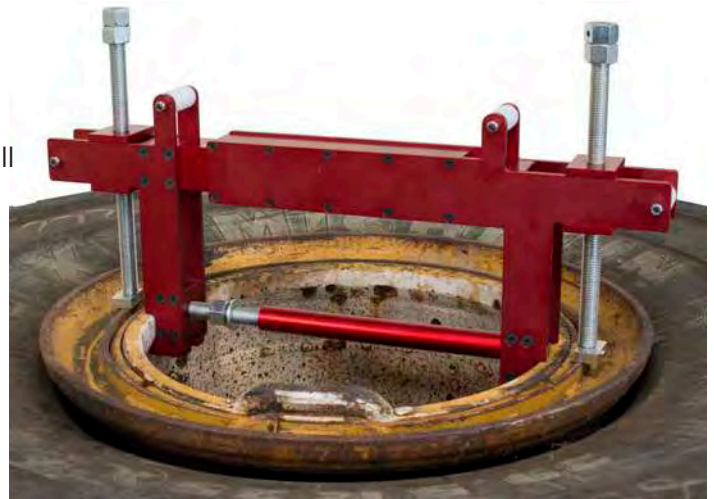

92200

OTR O-RING INSTALLER TOOL

- Installs/removes O-Rings on OTR assemblies up to 30" (76.2 cm)
- Pushes the rim flange back for easy installation of the O-Ring





OTR/MINING TIRE SERVICE



11900

BEAD SEAT BAND INSTALLER

- Uses hydraulic force to install bead seat bands in earthmover tires
- 25 tons of hydraulic force to ensure that all bead seat bands are installed effortlessly
- The angled plate rests against a large section of the tire, ensuring protection of the bead during installation
- Weight: 40 lbs (18.1 kg)



71670

SKIDDER BEAD KEEPER TOOL

- Custom designed tool to prevent the bead on large Skidder tires from “walking” during the mounting process
- Tool locks in to ensure safety
- Weight: 36 lbs (16.3 kg)



94000 TIRE BEAD HOOK

- Used to connect with hydraulic boom on tire service truck for transport of tires
- Has slim design which will fit inside all tires – even tires that have been stacked
- 5,000 lb (2,260 kg) capacity
- Weight: 34 lbs (15.4 kg)



94020 TIRE BEAD HOOK

- Used to connect with hydraulic boom on tire service truck for transport of tires
- 12,000 lb (5,400 kg) capacity
- Weight: 39 lbs (17.7 kg)



94010 TIRE BEAD HOOK

- Used to connect with hydraulic boom on tire service truck for transport of tires
- 16,000 lb (7,250 kg) capacity
- Weight: 66 lbs (29.9 kg)





TOOL TALK: CRIBBING & BLOCKING



AME INTERNATIONAL - CRIBBING & BLOCKING

We pride ourselves in working hand in hand with our customers to develop the products that better suit their needs. From our first days, our goal has been relatively simple: Service the Customer.

When lifting only with jacks, a load should be lowered onto stand or cribbing in order to comply with OSHA regulation 29CFR1926.305. OSHA 1926.305(d)(1)(i). After the load has been raised, it shall be cribbed, blocked, or otherwise secured at once.

ENGINEERED PLASTIC BENEFITS

- 100% recycled plastic construction for added durability against splitting, rotting, fluid absorption, termites and mold
- Unmatched strength - stronger than wood
- Resistant to gas, oil, and chemicals
- 50 year warranty against splitting, rot, fluid absorption, termites, or mold caused by the environment
- Lightweight and splinter free

Attribute	Plastic	vs.	Wood
Lightweight	Yes		No
Absorption	None		Everything
Get waterlogged and become heavier	No		Yes
Maintenance free	Yes		No
Resistant to oils, fuels, and lubricants	Yes		No
Prone to rotting, cracking, and splitting	No		Yes
Lab tested	Yes		No
Environmentally sound	Yes		No
PSI 800	250		
Warranty	50 years*		None
Certified	Yes		No

*Against splitting, rot, fluid absorption, termites, or mold.

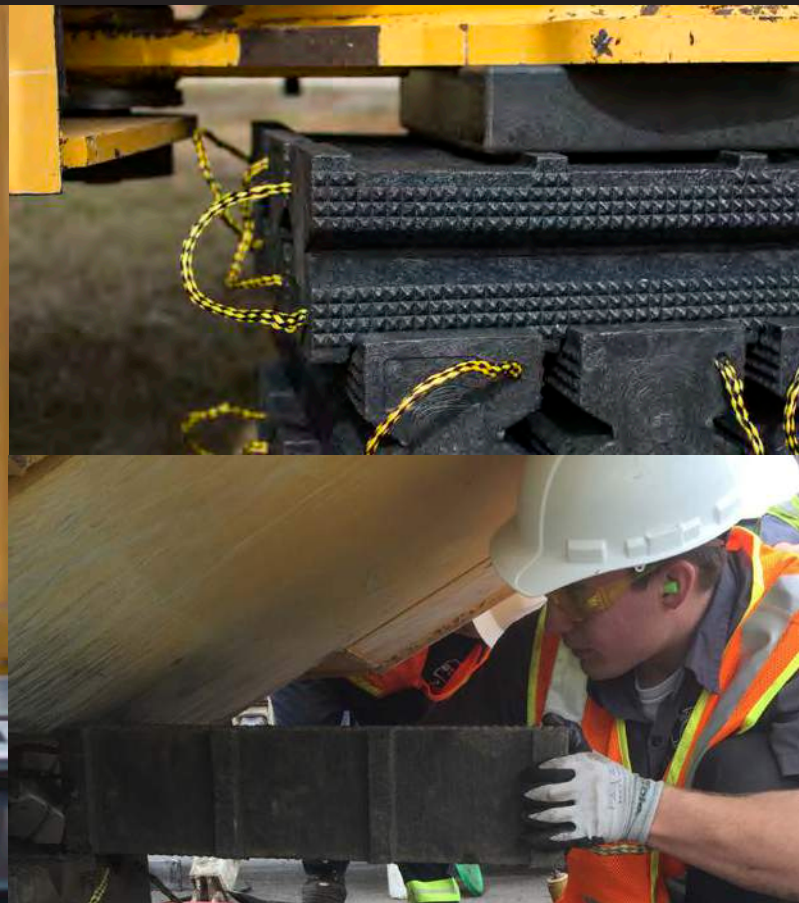

AME INTERNATIONAL SUPERSTACKER™ CRIBBING

The use of SuperStacker™ Cribbing (composite cribbing) in applications where wood and lumber were used, represents a commitment to certified safety that will outlast traditional wood cribbing 50 to 1. As it does not deteriorate, rot, splinter or fade; SuperStacker™ Cribbing is the safest choice when servicing or cribbing Heavy Duty OTR equipment.

SuperStacker™ blocks are designed to provide superior crib stability compared to standard hardwood and softwood products. Unlike wood products, SuperStacker™ cribbing blocks do not splinter or absorb fluids. Convenient sizes help to quickly and safely build stable cribs to support loads.

PRODUCT FEATURES

- Low maintenance
- Ultraviolet stabilizer against ultraviolet degradation (will not degrade if exposed to the sun)
- Long life expectancy
- No rotting or splintering
- Pyramid surface allows for a variety of stacking patterns
- If needed, SuperStacker™ cuts, drills and secures just like wood
- Environmentally friendly
- Resistant to marine borers, termites, fungus, salt and oils

OSH A 1926.305(D)(1)(I):

After the load has been raised, it shall be cribbed, blocked, or otherwise secured at once.





SUPERSTACKER™ CRIBBING



INDUSTRY APPLICATIONS

- Larger vehicles
- Railroad
- Construction
- Mining
- Dewatering
- Reassurance on the largest jobs
- Heavy duty construction

Item	Item Number	Description	Weight
A	15201	6" x 6" x 36"	38 lbs.
B	15202	4" x 4" x 36"	18 lbs.
C	15203	4" x 4" x 30"	17 lbs.
D	15230	6" x 7" x 30"	40 lbs.
E	15234	6" x 7" x 24"	27 lbs.
F	15245	6" x 7" x 30"	39 lbs.

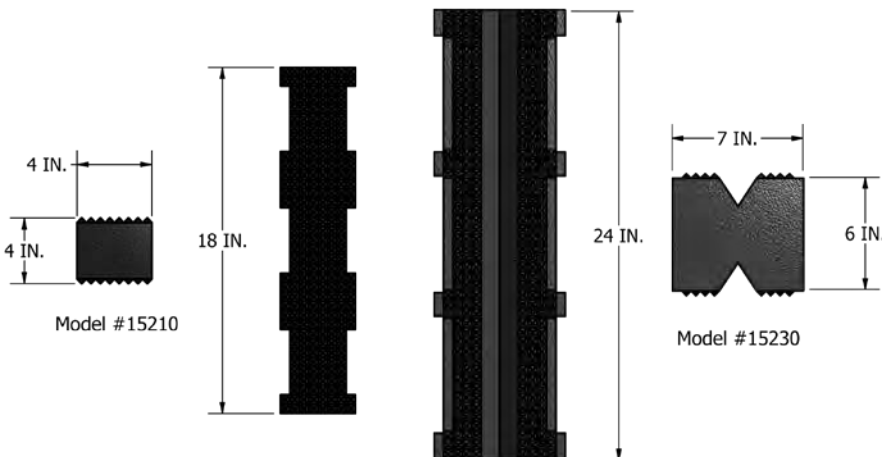
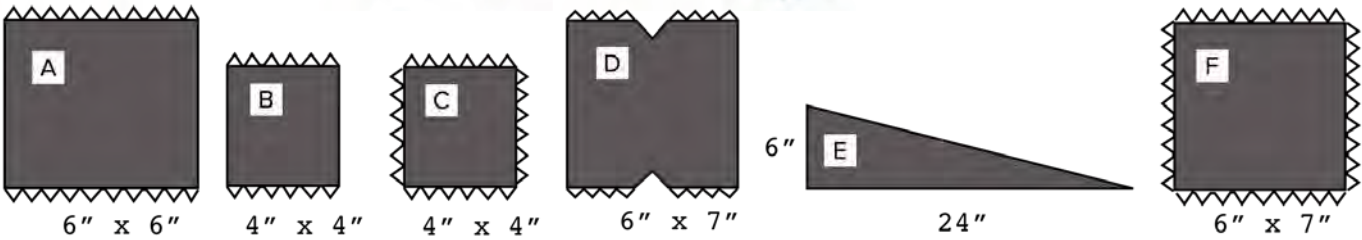

AME SUPERSTACKER™ CRIBBING BLOCKS

- Certified and Tested
- Multiple sizes, shapes fit most applications
- Interlocking or aggressive non-slip surface
- Non-conducting plastic resists oil and most chemicals
- Does not splinter, like wood

Model	Dimensions	Color
15210	4" x 4" x 18"	Black
15230	6" x 7" x 24"	Black

SUPERSTACKER™ CRIBBING



15660



15661



15662



15260

Kit provides 12 pieces of cribbing and is ideal for lifting up to 150 tons



15255

Ideal for use up to 85 tons



SUPERSTACKER™ CRIBBING BLOCKS

- Certified and Tested
- Multiple sizes, shapes fit most applications
- Interlocking or aggressive non-slip surface
- Non-conducting plastic resists oil and most chemicals
- Does not splinter, like wood
- Carrying lanyards provided on all 6" x 7" and on 4" x 4" crib blocks
- Made from 100% recycled plastic
- Rated up to 298,000 lbs (135,000 kg), depending on configuration
- Can be used with Lincoln log mating or pyramid mating
- Sold Separately or in kits (see table)

TOOL TIP:
The new #14468LT Jack Plate (pg. 37) interlocks with SuperStacker™ Cribbing blocks, providing a level surface and greater stability.

Kit Number	15210	15230	Jack Plate
15252	3	3	14465
15254		24	14468
15255	3	6	14465
15257		27	14468
15260		12	
15262		12	14466
15660		24	
15661		30	
15662		42	

15667 15668 15669

SASQUATCH® FOR TRACKED VEHICLES, PORTABLE & DURABLE, PADDED HANDLES

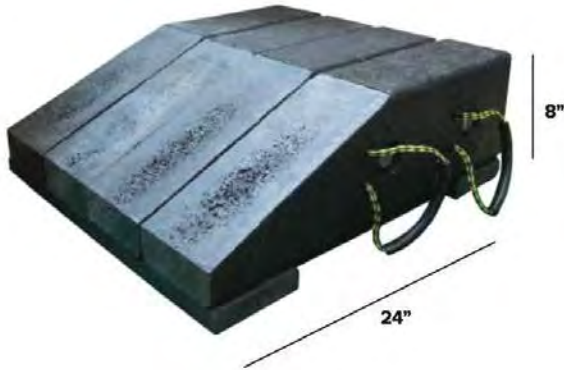

- Low-boy loading your track vehicle is a snap with the new Sasquatch®, part of the SuperStacker™ line
- Heavy duty construction with a 45° angle grade and three sizes to choose from
- Made in the U.S.A of 100% recycled plastic

Model	Description	Weight
15667	24"x8"x20.75"	108 lbs.
15668	24"x8"x16.5"	81 lbs.
15669	24"x8"x10.375"	54 lbs.

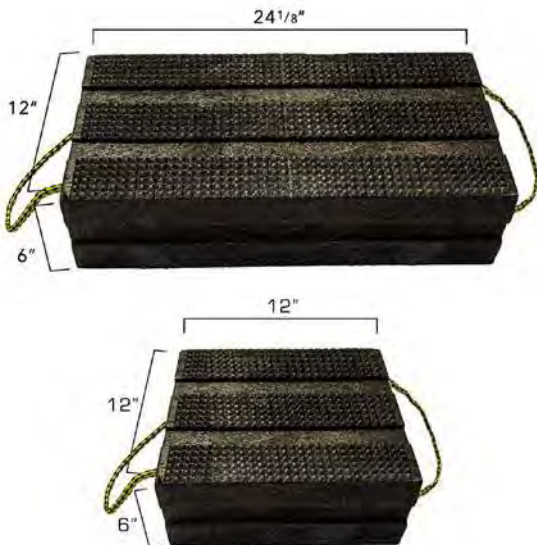

15231 15232

THE SLAB™ SUPER CRIB

- Reassurance on the largest jobs
- Heavy duty construction
- Available in full slab (#15231) or half slab (#15232)
- AME SuperStacker™ Cribbing is used in applications other than OTR as well!

Model	Description	Weight
15231	6" x 12" x 24"	80 lbs.
15232	6" x 12" x 12"	40 lbs.

15245 SUPER CRIB

- Reassurance on the largest jobs
- Heavy duty construction
- 6" W x 7" H x 30" L
- Weight: 39 lbs.



15002 STEEL CRIB KIT



- Steel cribbing is durable - will not bend or warp
- Model #15002 is a complete set - includes 3", 6" and 9" stands
- Units can be nested together for 18" total lift
- Recessed area on cribbing fits 7" square plate on 55 ton cylinders
- Each unit contains built in carrying handle
- Tested/Certified up to 100 tons

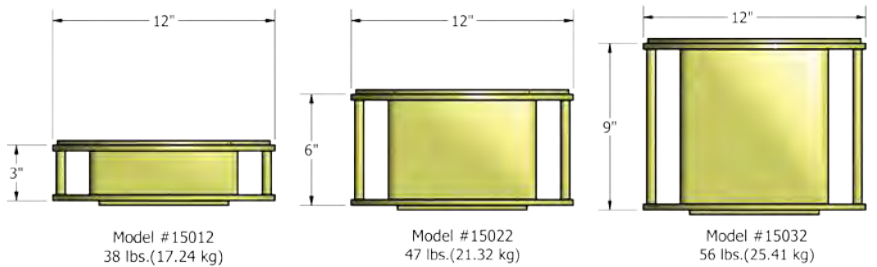

Model	Description	Weight
15012	3" Crib Stand	30 lb (13.61 kg)
15022	6" Crib Stand	53 lb (24.04 kg)
15032	9" Crib Stand	79 lb (35.83 kg)



Nesting Configurations

15012 & 15022: 9"
 15012 & 15032: 12"
 15012, 15022 & 15032: 18"

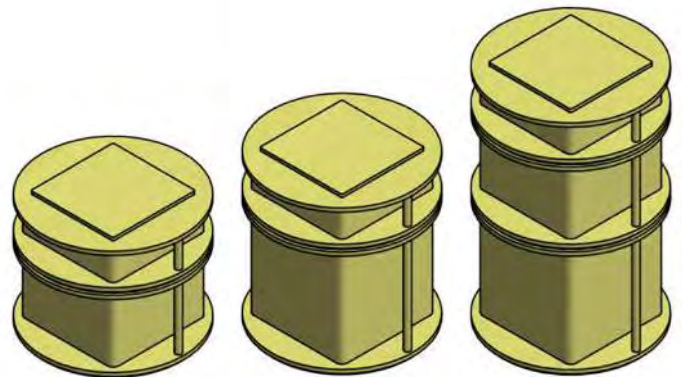



WHEEL CHOCK SAFETY GUIDELINES

PROPER CHOCKING PROCEDURES

- **Users must comply with all warnings and instructions provided with the wheel chocks.**

1. Inspect surrounding for safety hazards.
2. Park equipment on the flattest surface whenever possible.
3. Determine direction of the grade.
4. Wheel Chocks must be used in pairs, positioned firmly against the center of the tire. Wheel chocks must be position firmly agains the middle of the tire to maximize effectiveness. Improper use of the wheel chocks could decrease effectiveness.
5. Chock wheels according to 1- (a), 1-(b), 1- (c) depending on the grade.

6. Apply parking brake and secure work area.

- **It is the responsibility of the operator to make the final determination about appropriate chocking and safety measures under the circumstances present.**

- Many factors must be considered when chocking such as Tire Size, Tire Types, ground conditions (wet, ice, water, loose gravel, frozen etc.)

- Wheel chocks require proper inspection and need to be replaced when signs of cracking, chipping or other signs of stress on the wheel chocks.

- **When in doubt consult a supervisor.**

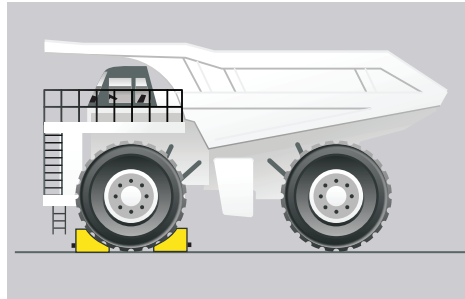

LEVEL GRADE 1-(a)

Place chocks around front wheels when on a level surface.

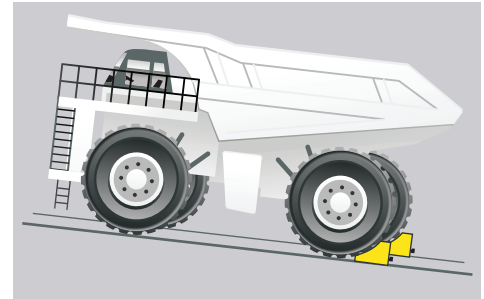

UPHILL GRADE 1-(b)

Place chocks behind back wheels when on an uphill grade.

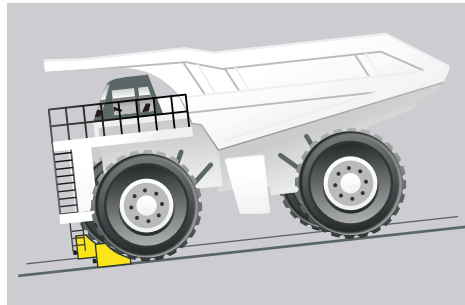

DOWNHILL GRADE 1-(c)

Place chocks in front of both the front and outer back wheels when on a downhill grade.



REMEMBER

Users must comply with all warnings and instructions provided with the wheel chocks. When in doubt, consult a supervisor.

OSHA SPECIFICATIONS



1910.178(k)(1)

The brakes of highway trucks shall be set and wheel chocks placed under the rear wheels to prevent the trucks from rolling while they are boarded with powered industrial trucks.

1910.178(m)(7)

Brakes shall be set and wheel blocks shall be in place to prevent movement of trucks, trailers, or railroad cars while loading or unloading. Fixed jacks may be necessary to support a semitrailer during loading or unloading when the trailer is not coupled to a tractor.

1910.111(f)(9)

Chock blocks. At least two chock blocks shall be provided. These blocks shall be placed to prevent rolling of the vehicle whenever it is parked during loading and unloading operations.

MSHA SPECIFICATIONS



30 CFR § 56.14207 - Parking procedures for unattended equipment.

Mobile equipment shall not be left unattended unless the controls are placed in the park position and the parking brake, if provided, is set. When parked on a grade, the wheels or tracks of mobile equipment shall be either chocked or turned into a bank. Unattended mobile equipment parked on a grade must have the wheels or tracks chocked or turned into bank in addition to setting the park brake (if provided) in order to prevent equipment from unexpectedly rolling and striking miners working in the area. Grade can be determined a number of ways, to include testing the equipment to determine if it rolls when the transmission is placed in neutral. This standard applies to all off-road and on-road self-propelled equipment used on mine property, including vehicles such as vans, suburbans, and pick-up trucks that are used at mine sites. Any piece of mobile equipment used on the mine site will have to comply with the standard. The standard would allow for mobile equipment parked on a grade to be turned into a bank, chocked, parked with the front or rear wheels in a ditch or trough.

WHEEL CHOCK APPLICATION CHART



MAKE	MODEL	SERIES	TIRE SIZE	WIDTH (IN)	DIAMETER (IN)	WIDTH (MM)	DIAMETER (MM)	AME MODEL #
Caterpillar	Dump Truck	797	59/80R63	57.76	158.15	1467	4017	15339
Caterpillar	Dump Truck	793C	40.00R51	43.62	140.75	1108	3575	15339
Caterpillar	Dump Truck	789	37.00R57	41.06	135.51	1043	3442	15339
Caterpillar	Dump Truck	785	33.00R51	36.69	120.51	932	3061	15338
Caterpillar	Dump Truck	777	27.00R49	29.53	106.61	750	2708	15338
Caterpillar	Dump Truck	775	24.00R35	25.98	86.38	660	2194	15338
Caterpillar	Dump Truck	773	21.00R35	22.72	80.63	577	2048	15337
Caterpillar	Dump Truck	769	18.00R33	20.28	74.41	515	1890	15337
Caterpillar	Artic Dump Truck	740	29.5-R25	33.46	73.43	850	1865	15337
Komatsu	Dump Truck	930	53/80 R63	51.34	150.71	1304	3828	15339
Komatsu	Dump Truck	830E	40.00R57	44.37	140.75	1127	3575	15339
Komatsu	Dump Truck	785	27.00 - R49	29.53	105.98	750	2692	15338
Komatsu	Dump Truck	730E	37.00 - R57	41.10	134.72	1044	3422	15339
Komatsu	Dump Truck	630E	36.00R51	39.96	126.14	1015	3204	15339
Caterpillar	Front End Loader	992G	45/65 x 45	44.21	107.48	1123	2730	15338
Caterpillar	Front End Loader	988	35/65 x 33	34.65	81.69	880	2075	15337
Caterpillar	Front End Loader	980	26.5 x R25	26.93	70.39	684	1788	15337
Caterpillar	Front End Loader	966	20.5 x R25	20.91	61.10	531	1552	15337
Caterpillar	Front End Loader	950	20.5 x R25	20.91	61.10	531	1552	15337
Caterpillar	Grader	14H	20.5-R25	20.91	61.10	531	1552	15337
Caterpillar	Grader	16G	18.00R25	20.28	64.49	515	1638	15337
Caterpillar	Grader	16H	23.5-25 R25	24.25	63.90	616	1623	15337
Caterpillar	Grader	16M	18.00R25	20.28	64.49	515	1638	15337
Caterpillar	Grader	24H	29.5 - R29	30.12	77.09	765	1958	15337
Caterpillar	Grader	24M	29.5 - R29	29.76	77.09	756	1958	15337
Caterpillar	Scraper	631G	37.50R35	37.56	94.02	954	2388	15338
Caterpillar	Scraper	621 & 623	33.25R29	34.02	81.73	864	2076	15338
Caterpillar	Scraper	657F	37.5R39	38.66	99.37	982	2524	15338
Caterpillar	Loader	994	53.5/85-57	29.53	75.59	750	1920	15337
Caterpillar	Loader	938	20.5-R25	20.91	61.10	531	1552	15337
Caterpillar	DP 150 Fork Lift	DP150	12.00-20					15336
Caterpillar	IT 28 Tool Carrier	IT 28	20.5-R25	20.87	58.86	530	1495	15337
Caterpillar	CS 663E Roller	663E	23.1-26	20.87	58.19	530	1478	15337
Mack	6 x 4 Truck							15336
Mack	8 x 4 Truck							15336

15336 WHEEL CHOCK, SIZE 5503



- Solid light weight construction, high impact urethane material
- Non-conductive, no threat to puncture the tire
- Durable, light weight, and easy to use - Extensively field tested
- Weight: 7.7 lbs (3.5 kg) Tire Size: 35 in to 55 in (900 mm to 140 mm)
- Wheel Chock Size: 13.3 in (L) x 8.6 in (W) x 7.8 in (H)
340 mm (L) x 220 mm (W) x 200 mm (H)

15353 WHEEL CHOCK, SIZE 5335



- Solid light weight construction, high impact urethane material
- Non-conductive, no threat to puncture the tire
- Durable, light weight, and easy to use - Extensively field tested
- Weight: 13.66 lbs (6.2 kg) Tire Size: 47 in to 70 in (1200 mm to 1800 mm)
- Wheel Chock Size: 13.38 in (L) x 9.84 in (W) x 7.8 in (H)
340 mm (L) x 250 mm (W) x 225 mm (H)

15337 WHEEL CHOCK, SIZE 5337



- Solid light weight construction, high impact urethane material
- Non-conductive, no threat to puncture the tire
- Durable, light weight, and easy to use - Extensively field tested
- Weight: 13 lbs (6 kg) Tire Size: 47 in to 86 in (1200 mm to 2200 mm)
- Wheel Chock Size: 18 in (L) x 12 in (W) x 9 in (H)
475 mm (L) x 305 mm (W) x 225 mm (H)

15341 WHEEL CHOCK, SIZE 5343



- Solid light weight construction, high impact urethane material
- Non-conductive, no threat to puncture the tire
- Durable, light weight, and easy to use - Extensively field tested
- Weight: 17 lbs (8 kg) Tire Size: 31 in to 110 in (790 mm to 2790 mm)
- Wheel Chock Size: 22 in (L) x 13 in (W) x 11 in (H)
559 mm (L) x 340 mm (W) x 280 mm (H)

15338 WHEEL CHOCK, SIZE 5304



- Solid light weight construction, high impact urethane material
- Non-conductive, no threat to puncture the tire
- Durable, light weight, and easy to use - Extensively field tested
- Weight: 19.8 lbs (9 kg) Tire Size: 70 in to 118 in (1800 mm to 3000 mm)
- Wheel Chock Size: 22.5 in (L) x 13 in (W) x 14 in (H)
570 mm (L) x 340 mm (W) x 355 mm (H)

15342 WHEEL CHOCK, SIZE 5342



- Solid light weight construction, high impact urethane material
- Non-conductive, no threat to puncture the tire
- Durable, light weight, and easy to use - Extensively field tested
- Weight: 24.3 lbs (11 kg) Tire Size: 86.6 in to 137.8 in (2200 mm to 3500 mm)
- Wheel Chock Size: 24 in (L) x 13.5 in (W) x 12 in (H)
621 mm (L) x 343 mm (W) x 323 mm (H)

15339 WHEEL CHOCK, SIZE 5306



- Solid light weight construction, high impact urethane material
- Non-conductive, no threat to puncture the tire
- Durable, light weight, and easy to use - Extensively field tested
- Weight: 30.86 lbs (14 kg)
- Tire Size: 110 in x 165 in (2800 mm to 4200 mm)
- Wheel Chock Size: 26.7 in (L) x 13 in (W) x 14 in (H)
680 mm (L) x 337 mm (W) x 355 mm (H)



15336-BR

URETHANE WHEEL CHOCK BRACKET

- Vertical stainless steel bracket for #15336 Wheel Chock



15337-BR

URETHANE WHEEL CHOCK BRACKET

- Galvanised steel single chock bracket for #15337 Wheel Chock



15338-BR

URETHANE WHEEL CHOCK BRACKET

- Galvanised bracket for #15338 Wheel Chock



15339-BR

URETHANE WHEEL CHOCK BRACKET

- Galvanised bracket for #15339 Wheel Chock



15353-BR

URETHANE WHEEL CHOCK BRACKET

- Galvanised bracket for #15353 Wheel Chock



15342-BR

URETHANE WHEEL CHOCK BRACKET

- Galvanised steel single chock bracket for #15342 Wheel Chock



WHEEL CHOCKS



15300 RUBBER WHEEL CHOCK

- Suitable for light and commercial wheels up to 35"
- Durable rubber construction
- Features an eye bolt for chain or rope attachment
- Ribbed pyramid design
- Either side of wheel chock can be positioned against the tire
- Sold individually
- Dimensions (LxWxH): 11.5 (292 mm) x 10" x (254 mm) x 7.25" (184 mm)
- Weight: 10 lbs (4.5 kg)



15301 BIG BLACK CHOCK

- Suitable for heavy duty and small OTR applications
- Solid rubber construction, hollow
- Steel handle for convenient carrying and lanyard mounting.
- Sold individually
- Dimensions (LxWxH): 11.75" (298.5 mm) x 11.5" (292 mm) x 10" (254 mm)
- Weight: 22 lbs (10 kg)

CHOOSING THE RIGHT WHEEL CHOCK



- **TIRE DIAMETER:** Be sure to pick the necessary AME wheel chock based on your vehicle's tire diameter.
- **SURFACE:** Know what type of ground you will be placing your wheel chock on when making your selection. Whether it's a gravel or paved surface, AME manufactures wheel chocks that adhere to all types of surfaces.
- **GROSS VEHICLE OPERATING WEIGHT:** Be sure you understand the vehicle's gross operating weight to ensure you select the correct wheel chock for your specific requirement.

CORRECT WHEEL CHOCK PLACEMENT



WARNING:
Place chock centered and squared to the tire. Position chock snugly against the tire tread.

15305

WHEEL CHOCK FOR SUPPORT MINE EQUIPMENT

- Rated for vehicles with a gross operating weight up to 245,000 lbs., and tire sizes up to 65" diameter
- Molded-in ANSI 2545.4 compliant proper chocking guidelines in English, Spanish and French with color illustrations
- Tough construction in safety yellow color, four side angles with carrying strap on back
- Replaceable rubber anti-slip traction pads
- Safety yellow color
- Dimension (LxWxH): 15" (381 mm) x 15" (381 mm) x 11" (280 mm), Weight: 14.5 lbs (6.6 kg)



15310

WHEEL CHOCK FOR MINE HAUL TRUCK WHEELS

- For vehicles with a gross operating weight up to 550,000 lbs., and tire sizes up to 105" diameter
- Molded-in ANSI 2545.4 compliant proper chocking guidelines in English, Spanish and French with color illustrations
- Maximum rated payload of 255 tons
- Tough construction in safety yellow color, four side angles with carrying strap on back
- Replaceable rubber anti-slip traction pads
- Dimensions (LxWxH): 17.7" (450 mm) x 15.2" (387 mm) x 10" (254 mm), Weight: 28 lbs (12.7 kg)



15315

WHEEL CHOCK FOR MINE HAUL TRUCK WHEELS, TALL VERSION

- For vehicles with a gross operating weight up to 1,600,000 lbs., and tire sizes up to 165" diameter
- A minimum of four 15315 wheel chocks must be used for gross vehicle operating weights from 855,000 - 1,600,000 lbs.
- Molded-in ANSI 2545.4 compliant proper chocking guidelines in English, Spanish and French with color illustrations
- Maximum rated payload of 400 tons
- Tough construction in safety yellow color, four side angles with carrying strap on back
- Replaceable rubber anti-slip traction pads
- Dimensions (LxWxH): 24.6" (625 mm) x 14.5" (369 mm) x 16" (407 mm), Weight: 42 lbs (19.1 kg)



15320

WHEEL CHOCK, HEAVY DUTY URETHANE

- For vehicles with a gross operating weight up to 855,000 lbs., and tire sizes up to 142" diameter
- Molded-in ANSI 2545.4 compliant proper chocking guidelines in English, Spanish and French with color illustrations
- Maximum rated payload of 255 tons
- Tough urethane construction in safety yellow color, four side angles with carrying strap on back
- Replaceable rubber anti-slip traction pads
- Dimensions (LxWxH): 21.9" (557 mm) x 14.9" (379 mm) x 10.6" (270 mm), Weight: 39 lbs (17.7 kg)



15309 WHEEL CHOCK



- Tough Urethane Construction, Safety Orange
- Chemical Resistant
- Mounting Brackets Available
- Meets NFPA & SAE Specifications
- Weight: 1.82 lbs (0.83kg) Tire Size 27 in to 35 in (685 mm to 889 mm)
- Wheel Chock Size: 8 in (L) x 7 in (W) x 6 in (H)
200 mm (L) x 178 mm (W) x 150 mm (H)

15355 WHEEL CHOCK

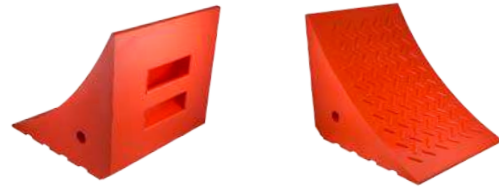

- Tough Urethane Construction, Safety Orange
- Chemical Resistant
- Mounting Brackets Available
- Meets NFPA & SAE Specifications
- Weight: 14 lbs (6.5kg) Tire Size 65 in to 95 in (1650 mm to 2410 mm)
- Wheel Chock Size: 17 in (L) x 14.5 in (W) x 14.5 in (H)
430 mm (L) x 368 mm (W) x 368 mm (H)

15308 WHEEL CHOCK



- Tough Urethane Construction
- Chemical Resistant
- Mounting Brackets Available
- Meets NFPA & SAE Specifications
- Weight: 5.8 lbs (2.63kg) Tire Size 18 in to 27 in (1200 mm to 2200 mm)
- Wheel Chock Size: 8.5 in (L) x 4.5 in (W) x 5.75 in (H)
215 mm (L) x 114 mm (W) x 146 mm (H)

15324 WHEEL CHOCK

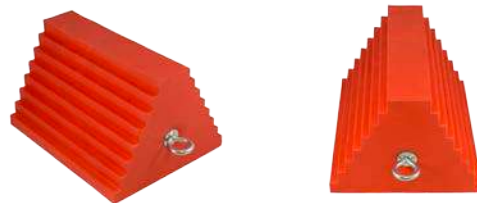

- Tough Urethane Construction, Safety Orange
- Chemical Resistant
- Pyramid Design
- Meets NFPA & SAE Specifications
- Weight: 2.8 lbs (1.3kg) Tire Size 27 in to 32 in (685 mm to 812 mm)
- Wheel Chock Size: 10 in (L) x 8 in (W) x 6 in (H)
250 mm (L) x 200 mm (W) x 150 mm (H)

15325 WHEEL CHOCK

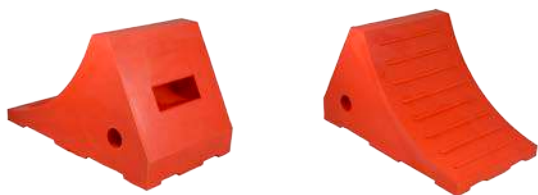

- Tough Urethane Construction, Safety Orange
- Chemical Resistant
- Mounting Brackets Available
- Meets NFPA & SAE Specifications
- Weight: 5.5 lbs (2.5kg) Tire Size 24 in to 32 in (600 mm to 810 mm)
- Wheel Chock Size: 14 in (L) x 7.8 in (W) x 7.8 in (H)
360 mm (L) x 200 mm (W) x 200 mm (H)

15367 WHEEL CHOCK

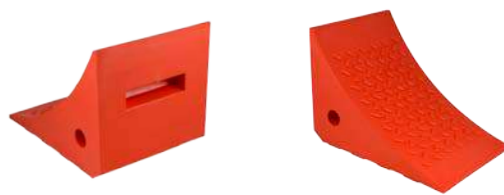

- Tough Urethane Construction, Safety Orange
- Chemical Resistant
- Mounting Brackets Available
- Meets NFPA & SAE Specifications
- Weight: 3.63 lbs (1.65kg) Tire Size 27 in to 35 in (6850 mm to 8890 mm)
- Wheel Chock Size: 11.5 in (L) x 8 in (W) x 8 in (H)
290 mm (L) x 200 mm (W) x 200 mm (H)

15366 WHEEL CHOCK



- Tough Urethane Construction, Safety Orange
- Chemical Resistant
- Mounting Brackets Available
- Meets NFPA & SAE Specifications
- Weight: 5.95 lbs (2.69kg) Tire Size 27 in to 32 in (685 mm to 812.8 mm)
- Wheel Chock Size: 10 in (L) x 8.5 in (W) x 5.5 in (H)
254 mm (L) x 216 mm (W) x 140 mm (H)

15345 DOZER TRACK FLOOR PROTECTION MATS



- These floor protection mats are an ideal replacement for old conveyor belt, which in the past has been a back breaking exercise moving the belt about the workshop.
- They provide the protection needed against the potential damage caused by heavy dozers & excavators driving onto the concrete floors while entering & exiting workshops.
- Reduces workplace back injuries.
- Each protection mat is: 39 in. (1000 mm) long, 31 in. (800 mm) wide, 0.71 in. (18 mm) thick, and weighs 39 lbs (18 kg).

15346 STAINLESS STEEL TROLLEY



- This stainless steel trolley holds 12 dozer track floor protection pads (#15345) at a time.
- The trolley can also be maneuvered safely & packed away neatly when not in use.
- Protection mats not included.

15351 / 15352 BLADE REST PADS



- Polyurethane Grader Rest Pads assist in protecting the concrete surface of workshop floors as well as entry & exit areas when equipment is parked up ready for maintenance.
- To be used in sets between the blade and the floor.
- Rest pads are available in two different sizes (each with molded handle):
- **#15351:** Standard, 23.62" (600 mm) x 7.87" (200 mm) x 1.97" (50 mm), 15.4 lbs (7 kg).
- **#15352:** Large, 23.62" (600 mm) x 15.75" (400 mm) x 1.97" (50 mm), 30.9 lbs (14 kg).

15349 / 15350 RIPPER REST PADS



- Ripper Pads protect workshop floors while removing the problem of lifting heavy steel pads into place.
- One unit with the raised edges for the types without the boot and the other completely flat both sides for rippers with boots.
- Units have been trialed and the type used has become a site preference.
- **#15349:** Standard, 15.75" (400 mm) x 18.31" (465 mm) x 1.57" (40 mm), 23.2 lbs (10.5 kg).
- **#15350:** Large, 26.57" (675 mm) x 11.8" (300 mm) x 1.97" (50 mm) 28.7 lbs (13 kg).

15360 DOZER MAINTENANCE 1 PIECE MATS



- Designed to strap on to dozer tracks and eliminate slip/trip hazards associated with maintenance activities when walking on dozer tracks.
- Available in two designs: A one piece ridged mat (#15360) for the workshop or in a two piece hinged mat (#15347 / #15348) suitable for the workshop or field maintenance.
- Each 1 pc. maintenance mat is: 33.86" (860 mm) wide x 77.36" (1965 mm) long and weighs 48.5 lbs (22 kg).

15347 / 15348 DOZER MAINTENANCE 2 PIECE MATS



- Designed to strap on to dozer tracks and eliminate slip/trip hazards associated with maintenance activities when walking on dozer tracks.
- Available in two designs: A one piece ridged mat (#15360) for the workshop or in a two piece hinged mat (#15347 / #15348) suitable for the workshop or field maintenance.
- **#15347:** Standard, 28.35" (720 mm) x 78.74" (2000 mm), 35.27 lbs (16 kg).
- **#15348:** Large, 33.88" (860 mm) x 78.74" (2000 mm), 48.5 lbs (22 kg).



14460

20 TON TITAN AIR/HYDRAULIC BOTTLE JACK

- Chromed ram and aluminum air motor for long life
- Heavy duty return springs
- Each unit factory tested at 150% overload
- Capacity: 20 Ton
- Minimum Height: 9.7" (24.5 cm), Maximum Height: 18.5" (46 cm)
- Weight: 38 lbs (17.5 kg)



14461

20 TON TITAN LOW PROFILE AIR/HYDRAULIC BOTTLE JACK

- Cylinder is welded to the base, assuring strength and eliminating leaks
- Chromed pump piston and ram for added rust resistance
- Extension screw gives added height when necessary
- Meets ANS/ASME PALD & CE/GS standards
- Super low minimum height for easy access
- Measurements: Height: 6" Length: 13" Width: 5"
- Minimum Height: 5.8" (148 mm), Maximum Height: 10" (256 mm)
- Weight: 21 lbs (9.5 kg)



14475

30 TON TITAN AIR/HYDRAULIC BOTTLE JACK

- Chromed ram and aluminum air motor for long life
- Heavy duty return springs
- Each unit factory tested at 150% overload
- Capacity: 30 Ton
- Minimum Height: 11" (27.9 cm), Maximum Height: 18" (45.7 cm)
- Weight: 60 lbs (27 kg)



14470

20 TON TITAN AIR/HYDRAULIC CART JACK

- 20 Ton capacity with welded steel base
- Chromed ram and aluminum air motor for long life
- Heavy duty return springs
- Each unit factory tested at 150% overload
- 36" long handle allows for easy placement of jack under vehicle
- Minimum Height: 10" (25.5 cm), Maximum Height: 19" (48 cm)
- Weight: 55 lbs (55 kg)

14160-14180

TELESCOPIC AIR HYDRAULIC JACK

- Two or three stages, hydraulic powered up and down, quick lift without load
- Long T-handle let's you easily position your jack under vehicle
- High polish chromed piston rods and cover boards for extended service life

Model	Capacity	Min. Height	Max. Height	Weight
14160	15/30 Tons	5.9" (15 cm)	11.8" (30 cm)	105 lbs (47.8 kg)
14180	10/25/50 Tons	5.9" (15 cm)	14.4" (36.6 cm)	143 lbs (65 kg)



14140

22-TON AIR/HYDRAULIC SERVICE JACK

- Air operated & easy to maneuver (operates with only 80 psi of air pressure)
- Single piece handle - will not break
- Extension saddles include: 1 of each, 1", 2", and 4"
- Min. Height: 9" (18.5 cm), Stroke Length: 6" (15 cm), Weight: 90 lbs (41 kg)



14140 SK
Saddle Kit





14360 9 TON JACK STANDS (PAIR)

- Ideal for forklift trucks
- Sturdy, welded steel construction
- Heavy gauge steel frame prevents distortion
- Capacity: 4.5 tons per stand, sold in pairs
- Min. height: 9.5" (24.1 cm), Max. height: 16.5" (41.9 cm)
- Weight: 27 lbs (12.3 kg)/Pair



14720 10 TON JACK STANDS (PAIR)

- European design accommodates truck axles, forklifts & trailers
- 4 pin placements
- Sold in pairs
- Capacity: 5 tons per stand
- Min Height: 11.25" (28.6 cm)
- Max Height: 18" (45.7 cm)
- Weight: 10 lbs (4.5 kg)



14980 6 TON FLAT TOP JACK STANDS (PAIR)

- Flat Top rubber pad grips the lifting point
- Ideal for low profile vehicles or custom cars
- Powder coat finish on base
- Zinc plated post to prevent rust
- Capacity: 3 tons per stand
- Sold in pairs
- Min Height: 13" (33 cm), Max Height: 21.5" (54.6 cm)
- Weight: 24 lbs. (10.9 kg)/Pair



14985 6 TON HIGH LIFT JACK STANDS (PAIR)

- Ideal for light aircraft, flat top rubber pad grips the lifting point
- Powder coat finish on base, zinc plated post to prevent rust
- Capacity: 3 tons per stand, sold in pairs
- Min. Height: 19" (48.3 cm)
- Max. Height: 31.5" (80 cm)
- Weight: 36.5 lbs (16.6 kg)/Pair



14400

40 TON HEAVY DUTY JACK STANDS (PAIR)

- Sturdy steel construction for superior safety and strength
- Heavy gauge, steel frame helps prevent distortion or twisting
- Capacity: 20 tons per stand, sold in pairs
- Min. Height: 9.5" (24.1 cm), Max. Height: 19.9" (50.5 cm), Weight: 72 lbs (32.7 kg)/Pair



14405

40 TON JACK STANDS, ADJUSTABLE TOP (PAIR)

- 3 lock pin settings for adjustable heights
- Adjustable Swivel allows for 2" of variance at locked settings
- Capacity: 20 tons per stand, sold in pairs
- Min. Height: 10" (25.4 cm), Max. Height: 21.9" (55.63 cm), Weight: 70 lbs (32 kg)/Pair



14425

24 TON HEAVY DUTY JACK STANDS (PAIR)

- Sturdy steel construction for superior safety and strength
- Heavy gauge, steel frame helps prevent distortion or twisting
- Capacity: 12 tons per stand
- Min. Height: 11.81" (30 cm), Max. Height: 18.11" (46 cm), Weight: 22 lbs (10 kg)/Pair



14410-14415

20 TON OTR SCREW STYLE JACK STANDS

- Screw style stand easily holds load at desired height and secures it with locking collar
- Adjustable screw for height extension and retraction
- Quick adjustment to desired heights
- Capacity: 20 tons per stand, sold individually



Model	Capacity	Min. Height	Max. Height	Weight
14410	20 Tons	16.5" (42 cm)	26.7" (68 cm)	60 lbs (27 kg)
14415	20 Tons	26" (66.5 cm)	46" (117 cm)	87 lbs (41 kg)





AC HYDRAULIC^{A/S} AIR HYDRAULIC JACKS



AC Hydraulic^{A/S}
NO COMPROMISE

AC HYDRAULIC^{A/S} AIR HYDRAULIC JACKS

AME International presents AC Hydraulic^{A/S} Air Hydraulic Jacks, designed for heavy-duty, intensive commercial use. Hard chromium plated piston rod for long life. Built-in safety overload valve. Hand-operated dead-man's control for optimum safety while lifting and lowering. Portable air hydraulic jack also available, ideal for service vans, etc. Handy design - no loose tubes, handles, or valves. All air hydraulic jacks have an air supply of 130 - 174 psi and an air consumption of 350 l/min. Air hydraulic jacks have a handle length of 53.35" (135.5 cm). Portable air hydraulic jack (B25-2) handle length: 21.65" (55 cm).

Model	Capacity	Min. Height	Max. Height	Total Width	Frame Length	Weight	Included Extensions
B25-2	25 / 10 tons	6.3" (16 cm)	9.3" / 12.6" (23.5 / 32 cm)	11.4" (29 cm)	21.1" (53.5 cm)	61.7 lbs (28 kg)	2" / 3.9" (5 / 10 cm)
25-1	25 tons	8.7" (22 cm)	13.6" (34.5 cm)	12 (30.5 cm)	30.3 (77 cm)	136.7 lbs (62 kg)	2" / 3.9" (5 / 10 cm)
25-1H	25 tons	14.2" (36 cm)	24" (61 cm)	12.2 (31 cm)	32.3 (82 cm)	156.5 lbs (71 kg)	2" / 3.9" (5 / 10 cm)
25-2	25 / 10 tons	7.1 (18 cm)	10.8" / 15" (27.5 cm / 38 cm)	12 (30.5 cm)	30.3 (77 cm)	132.3 lbs (60 kg)	2" / 3.9" (5 / 10 cm)
50-2	50 / 25 tons	8.7" (22 cm)	13.4" / 17.7" (34 cm / 45 cm)	12.4 (31.5 cm)	31.9 (81 cm)	176.4 lbs (80 kg)	2" / 3.9" (5 / 10 cm)
50-3	50 / 25 / 10 tons	5.9" (15 cm)	8.3" / 10.4" / 13.2" (21 / 26.5 / 33.5 cm)	12.2 (31 cm)	31.9 (81 cm)	147.7 lbs (67 kg)	2" / 3.9" (5 / 10 cm)



B25-2
Portable air hydraulic jack
Handy design - no loose tubes,
handles, or valves.



Easy to operate -
handle can be used for
carrying, lifting, lowering,
and maneuvering.

50-2

2-STAGE AIR HYDRAULIC JACK

- 2-stage air hydraulic jack for heavy buses and trucks
- Designed for heavy-duty, intensive commercial use
- Hard chromium plated piston rod for long life
- Built-in safety overload valve
- Hand-operated dead-man's control for optimum safety while lifting and lowering
- With 2 extensions 2" / 3.9" (5 / 10 cm)
- Capacity: 50 / 25 tons
- Minimum height of 8.7" (22 cm)
- Maximum height of 13.4" / 17.7" (34 cm / 45 cm)
- Frame length: 31.9 (81 cm)
- Handle length: 53.4" (135.5 cm)
- Width: 7.95 in (20 cm)
- Width (with wheels): 12.4 (31.5 cm)
- Air supply: 130 - 174 psi
- Air consumption 350 l/min
- Weight: 176.4 lbs (80 kg)



50-3

3-STAGE AIR HYDRAULIC JACK

- 3-stage air hydraulic jack for low buses and other low clearance vehicles
- Telescopic cylinders ensure an excellent maximum lift together with a low closed height
- Designed for heavy-duty, intensive commercial use
- Built-in safety overload valve
- Hand-operated dead-man's control for optimum safety while lifting and lowering
- With 2 extensions 2" / 3.9" (5 / 10 cm)
- Capacity 50 / 25 / 10 tons
- Minimum height of only 5.9" (15 cm) combined with a high lifting capacity
- Maximum height of 8.3" / 10.4" / 13.2" (21 / 26.5 / 33.5 cm)
- Frame length: 31.9 (81 cm)
- Handle length: 53.4" (135.5 cm)
- Width: 7.95 in (20 cm)
- Width (with wheels): 12.2 (31 cm)
- Air supply: 130 - 174 psi, Air consumption: 350 l/min
- Weight: 147.7 lbs (67 kg)





TIRE INFLATION CAGES

24440-24455

TIRE INFLATION CAGES

- Made from heavy-gauge steel tubing welded to a steel base
- Guards against blown lock rings and rims
- Meets or exceeds OSHA standards 29 CFR 1910.177
- Designed to meet OSHA regulation requirements for Medium, Heavy-Duty Truck, OTR, Tractor, and Super Singles
- Model #24425 - Especially designed for super single tires
- Model #24455 and #24456 - Especially designed for earthmover tires

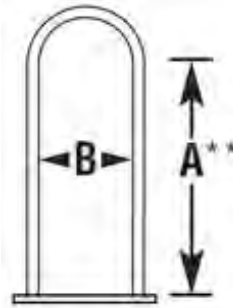

** For reference only. Height A refers to the approximate height to the inside bend of the cage. May accommodate taller tires.

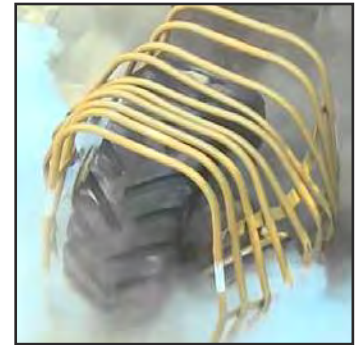

Absorbs explosions and contains all tire and wheel components

Model	Size	Type	Height A**	Width B	Base	Weight
24420	2 bar	Standard	41" (104 cm)	16" (41 cm)	7" closed x 21-1/2" (18 cm closed x 55 cm)	60 lbs (27.2 kg)
24425	2 bar	Super Single	43-1/2" (111 cm)	20-1/2" (52 cm)	7" closed x 27" (18 cm closed x 69 cm)	72 lbs (32.6 kg)
24430	3 bar	Standard	43-1/2" (111 cm)	20-1/2" (52 cm)	26" x 22" (66 cm x 56 cm)	134 lbs (60.7 kg)
24440	4 bar	Standard	43-1/2" (111 cm)	20-1/2" (52 cm)	31-1/2" x 26" (80 cm x 66 cm)	146 lbs (66.2 kg)
24450	5 bar	Standard	43-1/2" (111 cm)	20-1/2" (52 cm)	41" x 26" (104 cm x 66 cm)	182 lbs (82.5 kg)
24455	5 bar	Earthmover	41-1/2" (105 cm)	24-1/2" (105 cm)	48" x 30" (122 cm x 76 cm)	211 lbs (96 kg)
24456	10 bar	Earthmover	89" (226.1 cm)	48" (121.9 cm)	72" x 48" (182.9 cm x 121.9 cm)	820 lbs (372 kg)



Heavy duty steel construction

24145

UNICHEK DIGITAL GAUGE

- Digitally reads tire pressure for accuracy
- Available in 4 measurements – PSI, KPA, BAR and Kg/m
- Accurate and dependable
- Reads from 0 – 180 psi



24860

NITROGEN PURITY GAUGE

- Accurate and easy to use
- Compact and ergonomic in design
- Simple to operate, one button design
- Battery charge indicator
- Auto-power off function
- Replaceable battery and sensor
- Auto diagnostic with error code to simplify troubleshooting
- Dimensions: 12"x12"x5"
- Weight: 10 lbs (4.5 kg)



24820

AUTOMATIC TIRE INFLATOR

- Fits all applications general, tireshop and Nitrogen (N2)
- 3 modes in one inflator
 - Mode 1 - Standard inflate / deflate
 - Mode 2 - Tireshop mode with overpressure
 - Mode 3 - N2 fill and air to N2 Conversion
- Touch screen technology
- Designed to be simple and space-saving, without the programmability or customization of the more expensive models
- Works with single or multiple hose hook-up
- Weight: 8 lbs (3.6 kg)



24861

WHIP HOSES

- Has 1/2" ball valve with dial gauge for checking pressure
- Equipped with safety coupler for releasing the pressure in case of an emergency
- 1/2" NPT connection
- 3/8" ID for maximum air flow



24866

ACCU-FLATE DIGITAL TIRE INFLATOR



POWERED BY:
2x AAA BATTERIES



- Hose length: 20 in. (50.8 cm) with swivel, wire sheath on flex area of hose to eliminate kinking
- Retail packaging, supplied with official calibration certificate
- Die cast aluminium unit with rubber sleeve
- Fully automated, advance digital high precision reading
- Ideal for tire fitters
- Backlight LCD with 9 second auto off
- 3 in 1 function: Inflate, deflate, measure tire pressure
- Accuracy: ± 2 p.s.i.
- Units of measurement: PSI, BAR, kPA
- Longer hose sizes available
- Powered by: 2x AAA batteries (included)
- Battery Life (Full Battery): 65 hours (depending upon usage)



24867

ACCU-FLATE XL DIGITAL TIRE INFLATOR



POWERED BY:
2x AAA BATTERIES



- Hose length: 6 ft (182.88 cm), wire sheath on flex area of hose to eliminate kinking
- Retail packaging, supplied with official calibration certificate
- Die cast aluminium unit with rubber sleeve
- Backlight LCD with 9 second auto off
- Ideal for tire fitters
- Fully automated, advance digital high precision reading
- 3 in 1 function: Inflate, deflate, measure tire pressure
- Accuracy: ± 2 p.s.i.
- Units of measurement: PSI, BAR, kPA
- Powered by: 2x AAA batteries (included)
- Battery Life (Full Battery): 65 hours (depending upon usage)



24868

EASY-FLATE DIGITAL TIRE INFLATOR

- Hose Length: 5 ft (152.4 cm)
- Ideal for cars, trucks, bikes etc
- Auto-off after 90 seconds
- Maximum Pressure: 174 p.s.i.
- Large easy to read LCD display with audible warning
- Tough ABS case, high quality cardboard packaging
- Individually calibrated and tested
- Accuracy: +/-0.3 p.s.i.
- Units of measurement: PSI, BAR, kPa
- Rechargeable Lithium-Ion battery, charger included
- Battery Life (Fully Charged): 15 hours (depending upon usage)



24869

DURA-FLATE DIGITAL TIRE INFLATOR

- Supply Pressure: Maximum 200 p.s.i. (1380 kPa), Minimum 100 p.s.i. (690 kPa)
- Connection: Inlet 1/4" NPT, Internal thread
- Hose length: 20", dual hold-on chuck
- Body: Die cast aluminum with steel operating lever and impact absorbing bumpers, Laser etched serial number
- Pressure Range: 0-174 PSI, 0-1200 KPA, 0-12 BAR
- Gauge: Digital multi-scale gauge. PSI, KPA, BAR, backlight display
- Calibration: Supplied with official calibration certificate
- Auto OFF after 8 seconds, Auto ON once pressure is sensed or air inflation takes place
- Accuracy: ± 2 p.s.i. @ 25-75 p.s.i.
- Longer hose sizes available
- Powered by: 2x AAA batteries (included)
- Battery Life (Full Battery): 80 hours (depending upon usage)



BEST SELLER

POWERED BY:
2x AAA BATTERIES





HALTEC CORPORATION: INFLATORS



For over 45 years, Haltec Corporation has been the leader in the tire valve industry. When underground mines were transitioning from rail wheels to rubber tires, Haltec was there to design and manufacture the tire valve systems required to meet their technical needs.

AME International offers the complete Haltec Product Line. Contact your sales representative for more information.



89-F17

MOBILE AIRCRAFT INFLATION UNIT

IDEAL FOR MOBILE AIRCRAFT TIRE SERVICING

- Two high cylinder nitrogen tanks
- Can be used with all Haltec inflators



89TWIN-DS

DUAL SCREEN TIRE INFLATION SYSTEM

IDEAL FOR SERVICE CENTERS AND MOUNTING FACILITIES

- 1/2" inlet/outlet
- Operating range: 5-145 PSI
- Dual LCD screens indicate gauged and target pressure



89MTIS-5

MULTIPLE TIRE INFLATION SYSTEM

IDEAL FOR MULTIPLE TIRE SERVICING

- Inflates up to 5 wheels simultaneously at 5-145 psi pressure
- Semi pneumatic locking swivel wheel
- Color Coded 1/4" inflation hose
- 1/2" and 1/4" inlet/outlet
- Suitable for use with standard or large bore valves and core extraction tools
- Inlet pressure gauge
- Dual LCD screens indicate gauged & targeted pressure



89XDB

HIGH VOLUME INFLATOR

IDEAL FOR FLEET OPERATIONS, TIRE SERVICE CENTERS AND TIRE MOUNTERS

- Designed specifically for inflating large OTR tires
- 1/2" inlet/outlet
- Operating range: 5-145 PSI



89XTC

TEMPERATURE COMPENSATING INFLATOR

SPECIFICALLY DESIGNED FOR OTR INDUSTRIAL, MINING AND CONTINUOUS OPERATION APPLICATIONS

- 1/2" inlet
- Weather-proof hardware to withstand high impact, heavy use
- Wet and dry tire pressure compensation for normal and liquid filled tires
- Easily adjustable base/ambient temperature setting to optimize for any environment
- Wireless temperature transmitter
- Operating range: 5-145 PSI



71050

GOLDEN BUDDY TIRE CHANGING SYSTEM

- Mount and demount tool assemblies for 22.5 and 24.5 tires/wheels
- Heavy duty steel construction ensures long life
- Nylon rollers protect the bead
- Bead keeper
- Sold as a complete set
- Weight: 32 lbs (14.5 kg)





TIRE CHANGING TOOLS



71000

EASY BUDDY TIRE CHANGING SYSTEM

- Mount and dismount tire assemblies for 22.5 and 24.5 tires/wheels
- Includes Rim Protector to prevent rim scarring
- Easy to follow instructions
- Includes top bead removal tool and bottom bead removal tool
- Weight: 35 lbs (16 kg)



71635

SINGLE HOOK HEAVY DUTY WHEEL PULLER

- Eliminates need to crawl under vehicle
- No need to use sledge hammer to separate stuck wheels
- Saves time and improves safety
- High Chromium Steel Construction
- Single hook represents 95% of the North American truck market



#71631
Double hook
adapter

71410

HEAVY DUTY BEAD HOLDER

- Keeps truck tire bead from slipping during mounting of top bead
- Made of heavy duty polymer with built in shim for added strength
- A must have on all truck tire installations



72150

STEEL TRUCK BEAD HOLDER

- Clamps on wheels to prevent tire from "walking"
- No need for vise-grips
- For use on automatic tire changers and manual demount applications
- Made from heavy duty steel



71025

IMPACT TRUCK TIRE DE-MOUNTER

- Impact driven tire demounter
- Ranges from 10" ATV tires to 19.5" reverse hub truck tires and up
- Can be used with any 1/2" impact



71026

IMPACT BEAD BREAKER

- Impact driven
- Works on a wide variety of tire and wheel combinations
- Easily breaks the hardest bead
- Works off of an impact gun or pneumatic air ratchet



71027

TRUCK TIRE DE-MOUNTER

- A safe, quick, and reliable tire demounting tool that makes tire demounting a simple
- Pivot hooks ensure easy and positive operation
- Design eliminates aggressive stretching of tire bead
- Works on standard truck tires (22.5-24.5) and can be used for the first bead of super singles or double wide truck tires
- Weight: 17 lbs (8 kg)



71412

BEAD WEDGE

- The bead wedge guides the tires with stiffer side walls into the drop center when you are demounting
- Reduces bead damage and stretching
- Also helps when the weather gets cold and the rubber is less flexible
- Weight: 2 lbs (0.91 kg)



71413

TIRE-LOC BEAD KEEPER

- Bead keeper easily maintains a bead lock on a wide variety of tires
- Works well when used in pairs on larger Ag or Commercial Tires
- Weight: 1.50 lbs (0.68 kg)





WHEEL DOLLIES



71300 TRUCK WHEEL DOLLY

- Decreases back injuries when removing and replacing heavy truck tire/wheel assemblies
- 9 1/2" (24 cm) roller accommodates low profile tires
- Allows for easy removal and installation of tire/wheel assemblies
- Rollers allow for simple lug alignment
- For use with all 22.5 and 24.5 truck tires
- Weight: 18 lbs (8kg)



71320 SUPER SINGLE TRUCK WHEEL DOLLY

- Decreases back injuries when removing and replacing heavy truck tire/wheel assemblies
- 14" (35.5 cm) roller accommodates low profile tires
- Allows for easy removal and installation of tire/wheel assemblies
- Rollers allow for simple lug alignment
- For use with all 22.5 and 24.5 truck tires (including super singles)
- Weight: 26 lbs (12 kg)

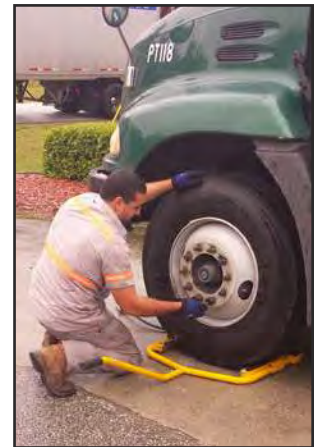

71335 HEAVY DUTY COMPACT WHEEL DOLLY

- 3,300 lb capacity
- Accommodates wheel diameters from 39" - 83"
- Maximum wheel width: 31 1/2"
- Shipping weight: 330 lbs (150 kg)
- Capacity: 2645 lbs. (1200 kg)
- Maximum height: 27.5" (700 mm)
- Weight: 250 lbs (118 kg)



AC HYDRAULIC^{A/S} WHEEL TROLLEYS



AC Hydraulic^{A/S}
NO COMPROMISE



WTA500

AC HYDRAULIC^{A/S} HYDRAULIC WHEEL TROLLEY, 0.5 TON

- Hydraulic wheel trolley for vans, trucks, buses, and removal of wheels and brake drums on aircrafts
- Flexible and ergonomic wheel trolley for the easy removal of wheels and brake drums
- High lifting height (28.23 in) is ideal for lifting e.g. wheels and brake drums off a transport wagon
- Lifting arms with roller bearings for easy rotation of the wheel into correct position
- Pedal operated pump leaving both hands free for working
- Bracket for easy securing of the wheel while transporting
- Hand operated dead man's release for optimum safety while lowering
- Ideal for lifting brake drums, fuel tanks, tool boxes etc.
- With 2 pcs. 360° revolving wheels



WTK AC HYDRAULIC^{A/S} TELESCOPIC CRANE ARM FOR WHEEL TROLLEYS

- Crane arm, fitted with 360° pivoting hook, for disc brakes, callipers, etc.
- Mounted with the telescopic crane arm, the wheel trolley is a universal lifting tool
- Easily swivels to one side to allow wheel removal operations to be carried out
- Offers efficiency and good ergonomics
- Capacity: 220 - 551 lbs



Model	Capacity	Lifting height	Height	Length	Width	Roller-/fork length	Roller distance	Wheel sizes (diameter)	Weight
WTA500	1100 lbs	28.2" (71.6 cm)	45.5" (115.5 cm)	34.2" (86.8 cm)	38.9" (98.8 cm)	16.3"/23.6" (41.4/59.9 cm)	10.2"-27.9" (25.9-70.8 cm)	10.63"-51.18" (27-129.9 cm)	220 lbs (99.8 kg)

WT1500

AC HYDRAULIC^{A/S} WHEEL TROLLEY, 1.5 TON

- Mechanical wheel trolley for tractors, agricultural and contractors' machinery
- Ergonomically designed for easy and efficient removal of large wheels and deep-treaded tractor tires
- Side-adjustable lifting arms for wheel diameters ranging 36.22 - 90.55 in
- Robust safety wheel retaining bracket for the safe maneuvering of the trolley
- Precise and easy lifting and lowering by means of mechanical operation
- Excellent maneuvering due to the 4 large, heavy-duty revolving wheels
- Lifting arms fitted with 3 roller bearings for ensuring the easy location of wheels
- Roller diameter: 3.15" (8 cm)



Model	Capacity	Height	Length	Width	Roller length	Roller distance	Wheel sizes (diameter)	Weight
WT1500	3300 lbs	53.5" (135.9 cm)	45.6" (115.8 cm)	66.1"-93.7" (167.9-237.9 cm)	29.1" (73.9 cm)	28.3"-54.3" (71.8-137.9 cm)	36.22" - 90.55" (91.9-229.9 cm)	331 lbs (150.1 kg)



67300 NUT BUDDY



- Bust loose the most stubborn wheel nuts
- Use on commercial or agricultural wheels
- Gear ratio - 58:1
- Rated output torque: 2,950 ft lbs
- Two sockets included: 1 1/2" (38mm) and 1 5/16th (33mm)
- Included extension handle used for removing wheel nut once it has been loosened by the Nut Buddy
- Weight: 19 lbs (8.5 kg)



62030 FOLDING TIRE STEP

- Fits on all 22.5 - 24.5 truck tires
- Enables you to create a step by placing the platform on most tires
- Step area designed to reduce slippage
- Durable steel construction
- Can be folded flat & stores easily
- Max rated capacity 400 lbs (181 kg)
- Weight: 19 lbs (8.5 kg)



Folded

Folded profile

67125 **BREAK BACK TORQUE WRENCH** **3/4" DRIVE**

- 200-750 ft. lb. range allows for nearly all applications
- Break back design - wrench "breaks" when torque is reached to prevent over tightening
- Works in either direction (for right or left hand threads)
- Length: 58" (147 cm)
- Weight: 16 lbs (7 kg)



67150 **BREAK BACK TORQUE WRENCH** **1" DRIVE**

- 200-750 ft. lb. range allows for nearly all applications
- Break back design - wrench "breaks" when torque is reached to prevent over tightening
- Works in either direction (for right or left hand threads)
- Length: 58" (147 cm)
- Weight: 16 lbs (7 kg)



67000 **TORQCHECK**

- Most affordable way to accurately check torque wrenches
- Accurate within +/- 2%
- Precision needle gauge measures from 0 - 180 ft. lbs.
- For use with all 1/2" torque wrenches
- Not to be used with impact wrenches
- Weight: 10 lbs (4.5 kg)





SAVE-A-STUD RETHREAD KITS



31210 SAVE-A-STUD RETHREAD KIT

- 9 Piece Rethread Kit
- Repairs damaged wheel studs
- Guaranteed for life
- For passenger, light truck, and heavy duty
- Individual dies available

SAE	Metric
7/16"-20	12mm-1.25
1/2"-20	12mm-1.50
9/16"-18	12mm-1.75
5/8"-18	14mm-1.50
	14mm-2.0



31250 SAVE-A-STUD RETHREAD KIT

- 3 Piece Heavy Duty Kit
- Repairs damaged wheel studs
- Guaranteed for life
- For passenger, light truck, and heavy duty
- Individual dies available

SAE	Metric
3/4"-16-RH	22m-1.50
3/4"-16-LH	



31270 SAVE-A-STUD RETHREAD KIT

- 5 Piece Unimount Ball Seat Kit
- Repairs damaged wheel studs
- Guaranteed for life
- For passenger, light truck, and heavy duty
- Individual dies available

SAE	Metric
1-1/8"-16-RH	22mm-1.50
1-1/8"-16-LH	
3/4"-16-RH	
3/4"-16-LH	



63010-63030

BUDD NUT WRENCHES

- Will not damage aluminum wheels
- Holds the outer nut securely on dual wheels
- Replaceable polymer head, part #63010-001



Model	Size	Weight
63010	1.5" (38 mm)	1.05 lb (0.48 kg)
63020	1.38" (35 mm)	1.05 lb (0.48 kg)
63030	1.61" (41 mm)	1.05 lb (0.48 kg)

69290

CHAMFER/NUT GAUGE

- Kit shows when wheel chamfers and wheel nuts are worn out
- Visual guide detects excessive wear in bolt holes
- For use with steel stud piloted wheels



61000-61090

TRUCK WHEEL GUARDS

- Composite separator plate to be placed between the hub or drum and the wheel, and/or between two wheels in dual applications
- Provides protection for wheels against corrosion and excessive wear
- Stops rust, scale, salt, and corrosion between steel disc rims in dual or single wheels
- Both aluminum and steel wheels can benefit from use of the Wheel Guard
- Prevents galvanic electrolysis between aluminum and steel wheels

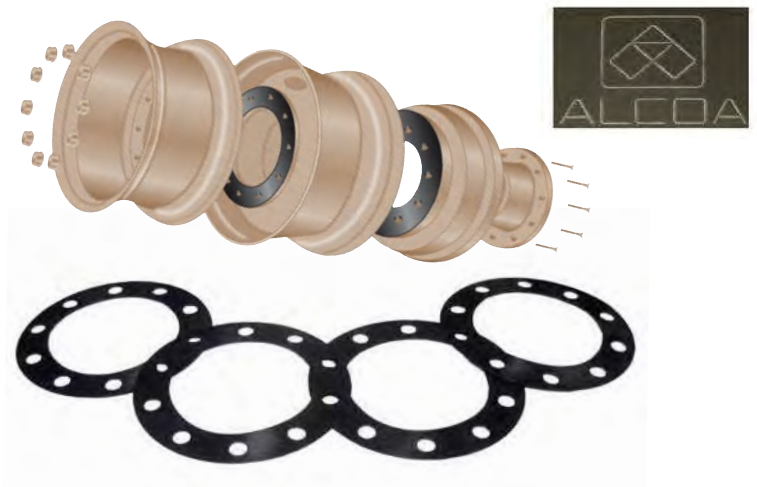

AME Model	Alcoa Model	Accuride Model	Description	Stud
61000	015000	5901	10 on 11 1/4" U.S. Bus mount	7/8"
61000	017000	5901	10 on 11 1/4" Stud piloted	1-1/8"
61010	016000	5902	10 on 11 1/4" Stud piloted	3/4"
61020	011000	5903	10 on 285.75mm Hub Piloted	22mm
61030	023000	7901	8 on 285mm, Japan ball seat steer/rear	20mm-30mm
61040	013000	7381	10 on 335mm	22mm
61040	018000	7381	10 on 335mm, 32mm sleeved	22mm
61050	012000	7902	8 on 275mm	20mm
61050	014000	7902	8 on 275mm	22mm
61060	-	8482	8 on 6 1/2", 4.82" ID, GM & Dodge	5/8"
61070	-	8525	8 on 6 1/2", 5.25" ID, Ford	5/8"
61080	-	8675	8 on 255mm, 6.25" ID, locating holes, Ford	5/8"
61090	-	5904	10 on 225mm, Ford 19.5	5/8"
-	024000	-	6 on 225mm	22mm



SKIRTED SLEEVE NUTS

58033-58036

SKIRTED SLEEVE NUTS

AME International announces our wheel sleeve product line to reduce wheel vibrations and help prevent the unpredictable wheel-off situations. This system is specifically designed for Class 8 Truck Steer & Drive Axles, and Trailers. In real world use, it is essential to re-torque all wheel nuts. This is attributed to components settling in or from temperature changes due to short bursts of starts and stops. The wheel is still held in position, concentric to the hub, however the wheel ends will vibrate, surfaces rust and "Clocking" occurs. Clocking, causes premature stud and stud hole wear. Over time wheel nuts loosen which is a dangerous condition. Standard wheel nuts clamp against the disc surface but fail to eliminate the extra space between the stud and the stud hole. Our line of wheel sleeve products helps lessen that space.



Note marks on the disc (just outside stud hole) caused by "clocking". This nut had been torqued to specifications and retorqued per factory settings.

STANDARD APPLICATIONS:

- The Sleeve offers more thread engagement and deeper penetration
- The chamfered nose allows for ease of wheel centering and installation

THE "SLEEVE"

- Protects and covers the threads from wear and the elements
- Reduces vibration and the wear and tear on wheel ends
- Fills the gap between the stud and the stud hole and allows the rim to rest on the sleeve
- Lengths designed for specific axle applications and wheel configurations



- 1) YELLOW HIGHLIGHT shows void between stud and stud hole.
- 2) Skirted Nut fills void between stud and hole.

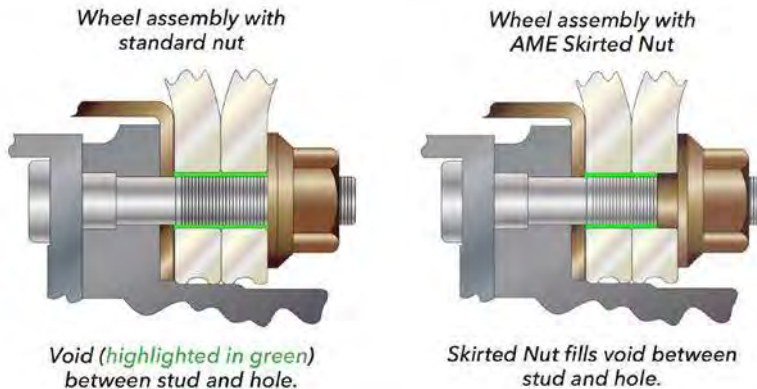

Model	Size	Description
58033	6 mm	Most popular skirted nut Designated for steel - steers
58034	19 mm	Designated for aluminum - steers Steel/steel - duals Steel outer / aluminum inner - drives
58035	28 mm	Designated for heavy duty aluminum Super single - wide base Steel outer / aluminum inner - drives
58036	39 mm	Designated for dual aluminum - drive axle

HEAVY DUTY WHEEL NUTS



STANDARD INNER CAP NUTS FOR STEEL & ALUMINUM WHEELS

Right Hand Model	Left Hand Model	Grade	Finish	Outer Thread	Inner Thread	Overall Length	Replaces
GL-1001	GL-1002	8.2	Yellow Dichromate	1 1/8" - 16	3/4" - 16	2 7/32"	Budd - 1079, Dayton - 13-3005L BWP - M129, Euclid - 7895L Leland - W695



STANDARD OUTER CAP NUTS FOR DUAL MOUNTED WHEELS

Right Hand Model	Left Hand Model	Grade	Finish	Inner Thread	Hex	Height	Replaces
GL-2001	GL-2002	8	Yellow Dichromate	1 1/8" - 16	1 1/2"	7/8"	Budd - 37891, Dayton - 13-3012R BWP - M126, Euclid - 5977R Leland - W746

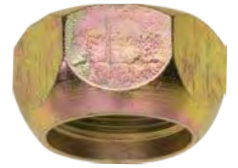

TWO PIECE FLANGE NUTS FOR UNI-MOUNT 10 HOLE SYSTEMS

Model	Grade	Finish	Inner Thread	Hex	Height	Replaces
GL-2301	8	Phosphate & oil	M22 - 1.5	M33	M32	Budd - 106333, Dayton - 13-3052 BWP - M3203, Euclid - 6000 Leland - W498



FLANGE NUTS FOR ALUMINUM WHEELS

Model	Description	Grade	Finish	Inner Thread	Hex	Sleeve Length	Recommended Use
GL-2919	Sleeve Nut	8	Black	M22 - 1.5	33 mm	19 mm	Aluminum-Steers Steel/Steel- Drives Steel Outer/Aluminum Inner - Drives
GL-2928	Sleeve Nut	8	Black	M22 - 1.5	33 mm	28 mm	Heavy Duty Aluminum Super Single - Wide Base Aluminum Outer/Steel Inner - Drives
GL-2939	Sleeve Nut	8	Black	M22 - 1.5	33 mm	39 mm	Dual Aluminum



FLANGE NUTS FOR ALUMINUM WHEELS

Model	Grade	Finish	Inner Thread	Hex	Height	Replaces
39946	8	Black	5/8" - 18	1 1/16"	13/16"	Alcoa - 39946, Dayton - 13-30510 Euclid - 10233, S/B - 102333 Leland - W749



FLANGE NUTS FOR ALCOA WHEELS

Model	Grade	Finish	Inner Thread	Hex	Height	Replaces
139987	8	Phosphate & oil	9/16" - 18	1 1/16"	7/8"	Alcoa - 139987





71600 LITTLE BUDDY MANUAL BEAD BREAKER

- Excellent for working on tire without removing wheel
- Great for all kinds of tires – ATV, golf cart, truck, bus, agricultural and even back hoe tires
- Operates with an air ratchet or manual wrench (not included)
- Weight: 12lbs (5.5 kg)



71500 BIG BUDDY BEAD BREAKER SLIDE HAMMER

- Easily breaks the most stubborn beads
- User fatigue is reduced through spring-action tip, which reduces kick-back
- Wedge tip is forced between the tire bead and wheel rim delivering the blow directly to the hammer tip
- Heavy duty tool with 1 year warranty
- Weight: 24 lbs (11 kg)

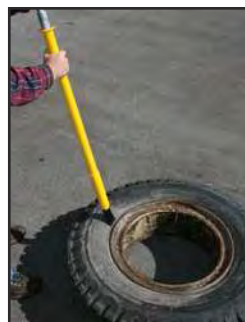

23800

5 GALLON CHEETAH TANK BEAD SEATER

- Point and release the cheetah tank bead seater to seat the bead on tubeless tires
- Bead seater makes seating the most difficult bead not only safe but simple, fast and economical
- ASME certified tank for commercial use, passenger, and ATV Tires
- Tank size: 5 gallon
- Tank type: steel
- Weight: 28 lbs (12.7 kg)



21000-22040

TUBELESS TIRE BEAD SEATER O-RING STYLE

- Economic way to seat beads
- Useful for difficult to seat tire beads
- Seat beads in 3 easy steps - lubricate, install and inflate



Model	Tire Type	Weight
21000	Passenger	13" - 14"
21010	Passenger	14" - 15"
22000	Truck	16.5" - 17.5"
22020	Truck	19.5"
22040	Truck	22.5" - 24.5"



HEAVY DUTY TIRE SERVICE: TIRE ADDITIVES



26156-26159

TIRE LIFE®

Tire Life® is a premium liquid formula developed to benefit all companies that manage commercial fleets.

- Protects tire liners from degrading and preserves original state
- Improves air retention by sealing natural liner porosity and vent hole leakage
- Improves the seal over buffed areas when a proper repair has been installed
- Decreases labor time for tire dismounting and air checks
- Excellent leak detector that safely identifies cracks in the rim base
- Flash point tested to 1500°C and cannot contribute to auto-ignition
- Protects wheels / rims against rust scale and pitting
- Seals the cracking and blistering of worn inner liners
- Eliminates the need for rim clean up and painting
- Reduces heat build up in tires
- Improves tire repairability
- Non-hazardous and non-toxic



Model	Quantity	Container
26159	6 gallon	Pail
26158	55 gallon	Drum
26156	275 gallon	Tote
26157	330 gallon	Tote



26148

OTR TIRE SEALANT

Because the seating of O-rings is not always consistent, this fibrous liquid product will maintain air pressure in the tire by stopping rim leaks and vent leaks. Faster OTR tire and rim removal, reduced downtime, labor and expenses.

- Seals punctures of up ¼"
- Lubricates rims and tire for quick and easy removal
- Eliminates rust on rims
- Tires run cooler
- Water based for easy clean-out
- Will not freeze
- Environmentally friendly and safe product, recognized by the United States E.P.A.

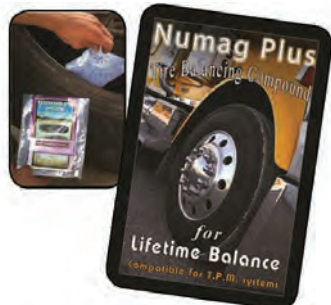

26110

NUMAG PLUS BALANCE COMPOUND

- Tire Balancing Compound constantly balances tires
- MicroBeads designed specifically for and compatible with TPMS valves
- Available in sizes for light truck, commercial and difficult to balance tires

HOW TO INSTALL NUMAG PLUS

1. Check application chart for correct size of Numag Plus
2. Clean rim and use tire lubricant sparingly
3. Open outer packet and drop INNER bag into tire
4. Use dry air for inflating tire and install nickel plated valve core and valve cap provided

Model	Bag Size	No. of Bags
26102C	2 oz	Case of 48
26103C	3.5 oz	Case of 36
26104C	4.5 oz	Case of 36
26106C	6.5 oz	Case of 24
26108C	8.5 oz	Case of 24
26110C	10.5 oz	Case of 20
26113C	13 oz	Case of 12
26116C	16 oz	Case of 12

LIQUID TIRE BALANCER



26140

LIQUID TIRE BALANCER (CASE OF 12, 32oz BOTTLES)

- Instant tire balance that increases the life of the tire, truck tires run 16% cooler
- Increases casing retreadability in new and retread tires
- Maintains air pressure – keeps bead area pliable and helps stop dry rot
- Eliminates rust on rims
- Tire changer friendly – mounting and dismounting is made easier
- Helps detect valve and tire damage and rim cracks
- Recap shop friendly – cleans out in seconds with wet vac
- Lubricates for a perfect bead seat (tire goes on true)
- Will not block valve stem
- Does not freeze
- Improves fuel mileage
- Environmentally friendly and safe product, recognized by the United States E.P.A. Meets E.P.A. standards for safe, risk-free disposal



Applicator tip and tube included



EASY TO USE

1. Connect hose to valve stem
2. Squeeze bottle to fill
3. Liquid Tire Balance can also be installed while the tire is demounted



STOPPED TIRE



AS YOU BEGIN MOVING THE TIRE BALANCING FLUID STARTS OUT EVENLY SPACED



AS A HEAVY SPOT GOES UP, THE FLUID IS FORCED DOWN TO A LIGHT SPOT



IT CONTINUES UNTIL BALANCED AND STAYS THAT WAY UNTIL YOU STOP

EACH TIME YOU STOP AND START THE FLUID RESETS TO THE MOST OPTIMAL PLACES. THIS MEANS THERE IS NEVER A NEED TO REBALANCE. LIQUID BALANCING COMPOUND KEEPS THE TIRE LUBRICATED FOR CONVENIENT AND SIMPLE TIRE MOUNTING & DEMOUNTING



14360 9 TON JACK STANDS (PAIR)

- Ideal for forklift trucks
- Sturdy, welded steel construction
- Heavy gauge steel frame prevents distortion
- Capacity: 4.5 tons per stand, sold in pairs
- Minimum height: 9.5" (24.1 cm)
- Maximum height: 16.5" (41.9 cm)
- Weight: 10 lbs (4.5 kg)



14385 5 TON / 4 TON FORKLIFT JACK

- Designed specifically for use on forklifts
- Features specially designed seals
- Strong steel construction with low pickup height
- 2.5" low clearance - jack fits under extremely low lift trucks
- Capacity: 5 tons on piston, 4 tons on scissor
- Minimum height: 2.5" (6.4 cm) low clearance
- Maximum height: 16" (40.64 cm) max lifting height
- Weight: 69 lbs (31 kg)



14370 7.5 TON FORKLIFT JACK

- Capacity: 7 Tons
- Minimum height: 2.25" (5.7 cm) low clearance
- Maximum height: 16.6" (41 cm) max lifting height
- Weight: 99 lbs (45 kg)



14300 14301 14302 FORKLIFT STABILIZATION SAFETY KITS (COMPOSITE CRIBBING & WHEEL CHOCKS)

Kits contain the basic Composite Cribbing and Wheel Chocks useful for safely working on FORKLIFTS. A convenient carrying bag is provided for smaller parts.



Model	Description	14300 Kit	14301 Kit	14302 Kit
15221	4" x 4" x 48"	2 pcs	2 pcs	2 pcs
15222	4" x 4" x 24"	2 pcs	2 pcs	2 pcs
15230	6" x 7" x 24" Super Crib			4 pcs
15234	6" x 7" x 24" Super Wedge			2 pcs
15236	6" x 7" x 12" /Lanyard	2 pcs	2 pcs	2 pcs
15237	Super Cribbing Carrying Bag	1 pc	1 pc	1 pc
15261	3" x 4" x 6" Riser		2 pcs	2 pcs
15281	Standard 3.5" x 3.5" x 9"	2 pcs	2 pcs	2 pcs
15282	Standard 3.5" x 3.5" x 12"	2 pcs	2 pcs	2 pcs
15283	Standard 2.5" x 3.5" x 6"	2 pcs	2 pcs	2 pcs
15302	Standard Wheel Chock/Lanyard	1 pc	1 pc	1 pc
15303	Small Wheel Chock/Lanyard	1 pc	1 pc	1 pc
15630	Medium Step Chock		1 pc	1 pc



AC Hydraulic^{AS}
NO COMPROMISE

65-1AP 65-1APH AC HYDRAULIC^{AS} AIR HYDRAULIC AIRCRAFT JACK

- Compact and slim design for easy operation and maneuverability
- Telescopic handle increases reach under the aircraft to 85.4" / 217 cm (65-1AP) or 90.3" / 229.3 cm (65-1APH) in and offers easy and safe operation
- The jack can be operated by either compressed-air, nitrogen from the aircraft wheels or a mobile nitrogen service cart
- Fitted with extension screw (3.15 in) for optimum use of the stroke
- Rapid ram retraction without load
- Manual lowering valve, safety overload valve and dead mans release
- Designed and manufactured according to the aircraft standards: EN1915:2001 and EN12312:2005



Model	Capacity	Min. Height	Max. Height	Frame Length	Handle Length	Total Width	Air Supply	Air Consumption	Weight
65-1AP	71.5 tons	10.59" (27 cm)	16.97" (43 cm)	31.89" (81 cm)	37.40" - 53.54" (95 - 136 cm)	12.20" (31 cm)	9 - 12 bar	350 l/min	187 lbs (85 kg)
65-1APH	71.5 tons	12.36" (31.5 cm)	20.47" (52 cm)	36.73" (93 cm)	37.40" - 53.54" (95 - 136 cm)	12.20" (31 cm)	9 - 12 bar	350 l/min	207 lbs (94 kg)

65-1H AC HYDRAULIC^{AS} HEAVY DUTY AIR HYDRAULIC JACK

- Air hydraulic jack for heavy duty/intensive commercial applications with high clearance
- Hard chromium plated piston rod for long life
- Built-in safety overload valve, hand-operated dead-man's control for optimum safety
- Capacity: 65 tons (143000 lbs)
- Minimum height of 16.65 in (42.5 cm)
- Maximum height of 28.50 in (72.5 cm) and with extensions up to 40.3 in (102.5 cm)
- With 2 extensions: 3.94 / 7.87 in (10 / 20 cm)
- Frame length 38.66 in (98 cm), handle length: 53.35 in (135.5 cm)
- Width (with wheels): 14.96 in (38 cm)
- Air supply: 9 - 12 bar, air consumption: 350 l/min
- Weight: 304 lb (138 kg)



14985 6-TON HIGH LIFT JACK STANDS (PAIR)

- Ideal for light aircraft, flat top rubber pad grips the lifting point
- Powder coat finish on base, zinc plated post to prevent rust
- Capacity: 3 tons per stand, sold in pairs
- Minimum Height: 19" (48.3 cm), maximum height: 31.5" (80 cm)
- Weight: 36.5 lbs (16.6 kg)





73100 AIR OPERATED TIRE SPREADER

- Air operated tire spreader (with stand)
- For passenger/RV/light truck tires
- Wide platform gives stable work surface
- Adjustable light
- Weight: 131 lbs (60 kg)



73200 AUTOMATIC TRUCK TIRE SPREADER

- Automatic Tire Spreader - the easiest way to repair tires
- Air lift allows operator to repair without lifting
- Heavy gauge steel
- Lamp included
- Air regulator / lubricator included
- Weight: 310 lbs (140kg)



73210

MY PAL - PORTABLE AUTOMOTIVE LIGHT

- Designed for hands-free lighting during tire service and other work applications
- Clamp-on handle quickly and easily “grips” over the bead of a tire for complete hands-free light assistance
- 12” adjustable spring-tube for optimum light positioning within tight spaces
- Compact high-power LED light provides up to 300 LUX intense focus and optimum visibility
- Compatible with all passenger, light truck, and commercial truck tires
- Compatible with all tire spreaders
- Multiple high-power magnets on the handle and light head attach easily to most metal surfaces
- Unique design provides unlimited vehicle service and work applications
- Lithium-ion rechargeable battery



73080

FLOOR MOUNT TIRE SPREADER

- Multiple height and width adjustments
- For use with passenger and light truck (13” - 20”)
- Heavy duty rollers cradle the tire
- Weight 63 lbs (29 kg)





AC HYDRAULIC^{A/S} HYDRAULIC JACKS



AC Hydraulic^{A/S}

NO COMPROMISE



AC HYDRAULIC^{A/S} HYDRAULIC JACKS

AME International presents AC Hydraulic^{A/S} Hydraulic Jacks, available in several models designed for passenger cars, low clearance cars, vans, and SUVs. Each jack is manufactured with a very low minimum height of only 3.15" (8 cm), a handle length of 37.4" (95 cm), as well as a wide and robust frame made of high-strength steel. Each model is fitted with quick-lift pedal for easy reach of lifting point and operates with precise and safe control while lowering. Manual dead man's release is also included for optimum safety when lowering, along with a built-in safety overload valve. Noiseless wheels incorporating a polyurethane central o-ring offer maximum surface protection. Ergonomically designed handle also ensures positive and safe operation.

Model	Capacity	Min. Height	Max. Height	Total Width	Frame Length	Weight
DK20Q	2.2 tons	3.15" (8 cm)	19.49" (49.5 cm)	16.14" (41 cm)	25.98" (66 cm)	68 lbs (31 kg)
DK13HLQ	1.45 tons	3.15" (8 cm)	28.94" (73.5 cm)	18.9" (48 cm)	37.01" (94 cm)	68 lbs (31 kg)
DK20HLQ	2.2 tons	3.15" (8 cm)	31.3" (79.5 cm)	19.69" (50 cm)	37.4" (95 cm)	108 lbs (49 kg)



GS-1
Rubber Cushion
For protection of car body



AC HYDRAULIC^{A/S} TRANSMISSION JACKS



AC Hydraulic^{A/S}
NO COMPROMISE

AC HYDRAULIC^{A/S} TRANSMISSION JACKS

AME International presents AC Hydraulic^{A/S} Transmission Jacks, pedal operated and perfect for those who need both hands free for work. Each jack allows precise adjustment and positioning. All jacks come with some form of safety feature such as a hand operated dead man's release and/or a built-in safety overload valve for optimum safety while in use. Models VL6 / VL10 / VLT12 are manufactured with a galvanized support saddle and base frame.

Model	Capacity	Stroke	Min. Height	Max. Height	Width	Wheel Diameter	Air Supply	Weight
VL6	0.65 tons	-	44.49" (113 cm)	77.36" (196.5 cm)	20.87" (53 cm)	3.15" (8 cm)	-	73 lbs (33 kg)
VL10	1.1 tons	-	46.06" (117 cm)	78.74" (200 cm)	21.65" (55 cm)	4.92" (12.5 cm)	-	88 lbs (40 kg)
VLT6	0.65 tons	47.05" (119.5)	28.35" (72 cm)	75.39" (191.5 cm)	37.4" (95 cm)	4.92" (12.5 cm)	8.5-12 bar	111 lbs (53 kg)
VLT12	1.3 tons	-	35.63" (90.5 cm)	75.59" (192 cm)	28.35" (72 cm)	4.92" (12.5 cm)	-	150 lbs (70 kg)





14720 10 TON JACK STANDS (PAIR)

- European design accommodates truck axles, forklifts & trailers
- 4 pin placements
- Sold in pairs
- Capacity: 5 tons per stand
- Min Height: 11.25" (28.6 cm)
- Max Height: 18" (45.7 cm)
- Weight: 10 lbs (4.5 kg)



14980 6 TON FLAT TOP JACK STANDS (PAIR)

- Flat Top rubber pad grips the lifting point
- Ideal for low profile vehicles or custom cars
- Powder coat finish on base
- Zinc plated post to prevent rust
- Sold in pairs
- Capacity: 3 tons per stand
- Min Height: 13" (33 cm)
- Max Height: 21.5" (54.6 cm)
- Weight: 12 lbs. (5.5 kg)



67301 NUT BUDDY JR.

- Bust loose the most stubborn wheel nuts
- Use on cars and light trucks
- Gear ratio-18:1
- Rated output torque: 885 ft. lbs.
- Three sockets included: (17mm) (19mm) (21mm)
- Weight: 5 lbs. (2.2 kg)



37330



HUB BUDDY XL IMPACT RATED LUG / DISC SURFACE CLEANER

- Impact rated - no need to change tools
- Comply with best practice R.I.S.T. procedure
- Removes rust, corrosion and other build-up from wheel stud, drums and tire rim
- Helps proper torque of lug nuts by removing corrosion
- A must for easy and accurate tire balancing
- Includes: 1 Hub Buddy XL attachment and 1 cleaning disc head
- Replacement cleaning discs available in packs of 6 (Model #37335)



COMPLIES WITH R.I.S.T. PROCEDURE

- R** - REMOVE DEBRIS FROM MATING SURFACE
- I** - INSPECT COMPONENTS
- S** - SNUG LUG NUTS IN STAR PATTERN
- T** - TORQUE LUG NUTS TO SPECIFICATION



37335

REPLACEMENT CLEANING DISCS FOR MODEL #37330 HUB BUDDY XL

- Replacement cleaning discs for model #37330 Hub Buddy XL Lug / Disc Surface Cleaner
- Available in packs of 6
- Does not included model #37330 Hub Buddy XL

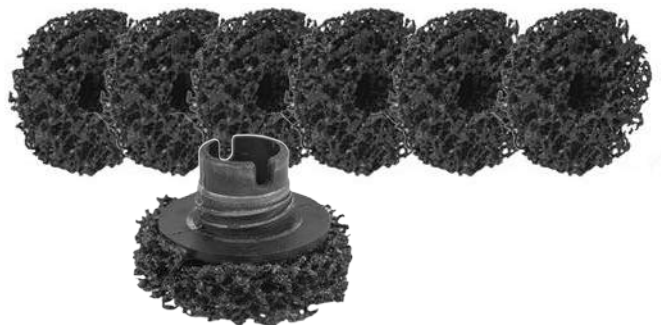



AUTOMOTIVE WHEEL TOOLS



51200 WHEEL WEIGHT PLIERS

- European style clip-on wheel weight installation & removal tool
- "Clip Claw" crowbar
- PVC coated grips handles for comfort
- Heavy hammer head
- Made from forged vanadium steel for extended tool life and stability
- Removes, trims and installs clip-on wheel weights
- A handy pliers for many wheel service jobs
- Lever for removing wheel covers
- Offset flat tip for removing wheel covers



51210 WHEEL WEIGHT PLIERS

- Soft head protects rims with non-marking rubber or polymer compounds with soft PVC coated handle
- Installs and removes Clip
- Style Leads and Steel Wheel Weights



51220 WHEEL WEIGHT PLIERS

- This passenger car wheel weight installation tool is the industry standard
- Wheel weight pliers install, trim and remove all types of wheel weights
- Heavy commercial duty design
- Coated handles for comfort
- Nickel plated vanadium



51290 WHEEL WEIGHT PLIERS

- European style clip-on wheel weight installation & removal tool
- "Clip Claw" crowbar
- Made from steel with black oxide finish
- PVC coated handles for comfort
- Heavy hammer head
- Made from forged vanadium steel for extended tool life and stability



51250 REPLACEMENT HEAD

- Replacement soft polymer head cap for model #51210 Wheel Weight Plier

51300

WHEEL WEIGHT PLIERS

- European style clip-on wheel weight installation & removal tool
- "Clip Claw" crowbar
- PVC coated grips handles for comfort
- Heavy hammer head
- Made from steel with black oxide finish
- Removes, trims and installs clip-on wheel weights
- A handy plier for many wheel service jobs
- Lever for removing wheel covers
- Offset flat tip for removing wheel covers



51310

WHEEL WEIGHT PLIERS

- For removal and hammering of wheel weights
- Nylon cap helps to keep wheels from getting scratched while putting on weights



51450

SOFT HEAD PLIERS & HAMMER/WEIGHT SCRAPER

- Removes wheel hubs and dust caps quickly and easily without scratching
- Large rubber hammer is designed to prevent damage



51480

WHEEL WEIGHT PLIERS

- Deluxe wheel weight hammer easily removes and installs wheels weights
- Made of heat strengthened steel
- Comfortable vinyl handles grips
- Nylon durable hammer tip (replaceable)





AUTOMOTIVE WHEEL TOOLS



51456 SOFT HAMMER, ORANGE

- Specifically designed for tire service
- Safe on all metal wheel surfaces, no metal-on-metal contact
- Reduces rebound and user fatigue
- Weight: 8 lbs (3.63 kg)
- Convenient for driving tire bead wedges (model #75005)



51470 SOFT HEAD HAMMER WITH CLAW HOOK

- Cast steel body with soft head
- Hammer is ideal for hammering coated weights
- Claw hook is replaceable
- Solid wood shaft



51460 ADHESIVE WEIGHT SCRAPER

- Heavy duty construction
- One piece composite
- Can be hit with a hammer
- Resharpen when needed
- Removes wheel weights, emblems, or body molding
- Scrape off wheel weights, stickers, paint, or gasket



51140 VALVE STEM AND CORE REMOVERS

- Ideal for quick removal of valve stems and for seating newly installed valve stems
- Units offers steel construction with heavy duty nylon boot that will not wear or mar aluminum



51070 VALVE STEM AND CORE REMOVERS

- Ideal for quick removal of valve stems and for seating newly installed valve stems
- Heavy Duty Polymer to resist scratching alloy wheels



51170 VALVE STEM AND CORE REMOVERS

- Ideal for quick removal of valve stems and for seating newly installed valve stems
- Polymer construction with steel rod for extra strength

69270

TREAD DEPTH GAUGE

- Material: Stainless steel
- Easy to read numbers
- Precise with tread depths in millimeters, inches, and fractions at 1/32 increments



72100

TIRE MOUNTING CLAMP

- Mounting clamp saves time when mounting tires
- Fits all passenger rims
- Clamp holds tire bead while mounting tire, will not allow tire to “walk”
- Constructed of heavy duty polymer for long life
- Will not scratch, mar or damage custom wheels



69280

DIGITAL TREAD DEPTH GAUGE

- Displays tread depths in millimeters, inches and fractions at 1/32 increments
- Appropriate for measuring brake shoe and pad wear
- Easy to read large LCD display
- Zero function allows for a zero gauge at any point making readings quick and accurate
- Manual power on/off



72105

TIRE MOUNTING CLAMP

- Mounting clamp saves time when mounting tires
- Fits all passenger rims
- Clamp holds tire bead while mounting tire, will not allow tire to “walk”
- Constructed of heavy duty polymer for long life
- Will not scratch, mar or damage custom wheels





AUTOMOTIVE TIRE CHANGER ACCESSORIES



72000

THE WONDER BAR MAG WHEEL TOOL

- Will not damage aluminum or mag wheels
- Works with all center post tire changers
- Polymer inserts securely attach to tool
- Polymer inserts outlast standard booties



72001

THE "ORIGINAL" MAG WHEEL TOOL

- Prevents damage on aluminum, chrome, and mag wheel
- Fits on all center post tire changer machines
- Replaceable polymer inserts
- Eliminates "booties" that slip off "combo" tool.
- Shipped complete with one set of replacement polymer inserts.



72010

WONDER BAR MAG WHEEL TOOL NOSE & HOOK KIT

- Kit include one nose end (72020) and one hook end (72040)



72020

WONDER BAR MAG WHEEL TOOL NOSE

- Polymer Nose insert for model #72000



72040

WONDER BAR MAG WHEEL TOOL HOOK

- Polymer Hook insert for model #72000

72005

MOUNT/DEMOUNT COMBO TOOL

- Designed for mounting and demounting tires on a center post tire changers
- Mount/Demount inserts work with combo tool to protect aluminum wheels



72210

LARGE WHITE DEMOUNT BOOTIE

- Fits on center post tire
- Changer blade and prevents scratching of aluminum rims



72220

SMALL WHITE DEMOUNT BOOTIE

- Fits on center post tire
- Changer blade and prevents scratching of aluminum rims



51500

WHEEL RIM MEASURING DEVICE

- Measures width of wheels /rims while balancing
- Same tools used on Corghi, Coats, CEMB and other OEM balancers
- Universal wheel balancer caliper to measure wheels
- Measures 3"-14" wide
- Measures I.D. & O.D in 1/2" or 1" increments. Ranges from 0" to 14" wide rims
- Used with major OEM balancers: Ammco, Corghi, Coats and CEMB. Constructed of ABS for strength and durability
- OEM / Aftermarket Interchanges: WB309011, 309011, 8309011, 110007, FMC 61123
- Measures I.D. & O.D in 1/2" or 1" increments
- Measures up to 14" Wide Rims
- Strong, Durable ABS Plastic



51550

WHEEL RIM MEASURING DEVICE

- Measures width of wheels /rims while balancing. Same tools used on Corghi, Coats, CEMB and other OEM balancers
- Bolt pattern measuring gauge will measure almost all of your common bolt pattern
- Easy to use slider tool
- Manufactured from heavy duty polymer for long life





TIRE LUBE ACCESSORIES & SPARE TIRE TOOLS

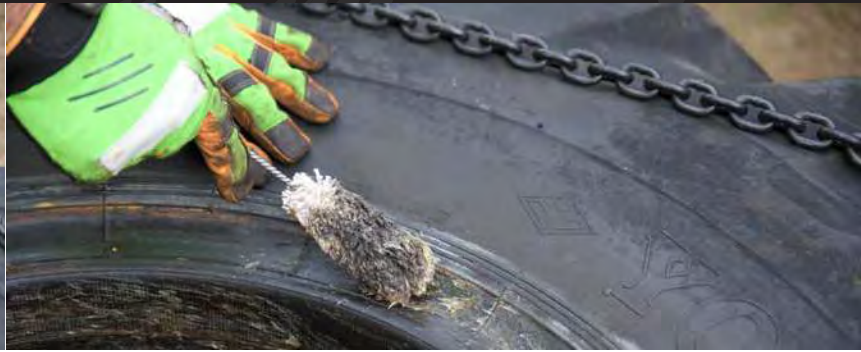

79010 TIRE CHANGER LUBE BUCKET (ANGLED)

- Angled tire changer Lube bucket
- O.E.M application: Coats 4040, 4040SA & 4050



79040 TIRE CHANGER LUBE BUCKET (STRAIGHT)

- Straight tire changer lube bucket
- O.E.M application: Coats 5030, 5060 and 5065



79020 14 1/2" TIRE SWAB AND BRUSH

- Used to lubricate tire beads when mounting or removing tires
- 14 1/2" (37 cm) long swab



79030 11 1/2" TIRE SWAB AND BRUSH

- Used to lubricate tire beads when mounting or removing tires
- 11 1/2" (30 cm) long swab

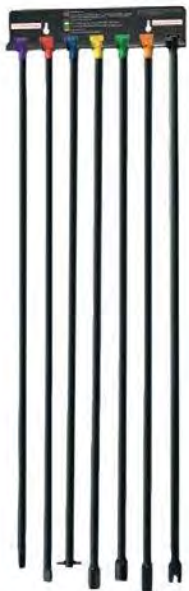

71100 SPARE TIRE TOOL SET

- Allows quick access to spare tires
- 8 pc set has 7 individual tools and wall rack
- Set covers 95% of pickup/SUV market
- Color coding allows for quick access



72110

HEAVY DUTY FORGED TIRE BARS

- Forged steel with chrome plate finish
- Curved spoon and curved offset hook ends
- Use with tire machine or manually
- Heavy duty commercial quality tire bar
- Mounts and demounts tires on wheels and rims
- 20" (50 cm) in length



72120

HEAVY DUTY FORGED TIRE BARS

- Forged steel with chrome plate finish
- Curved spoon and curved offset hook ends
- Use with tire machine or manually
- Heavy duty commercial quality tire bar
- Mounts and demounts tires on wheels and rims
- 24" (60 cm) in length



72080

TUFFBAR

- Entire top surface is covered with tough protective polymer plates so there is NO contact between the metal bar and the rim
- Greater length for more leverage
- Forged steel makes Tuffbar stronger than standard bars
- Perfect for mounting low profile tires on large wide diameter alloy rims without bending
- Use with existing rim clamp machines the same way as your regular bar
- The replaceable polymer plates are secure, NO BOOT to shift position or fall into the tire



Model	Description
72081	Polymer insert - Front Red
72082	Polymer insert - Center White
72083	Polymer insert - Rear Blue
72084	Polymer insert - Bottom Black
72085	Repair Kit, includes: 72081, 72082, 72083, 72084, & screws

72140

LOW PROFILE TIRE BAR

- Easy grip knurled handle gives the user better control of the tool
- Angled handle for better leverage and easy mounting of low profile/tough beads, also reduces the chance of damaging expensive wheels
- Leverage designs also allows for reduced strain on users' hands and wrists
- 2 inches longer than a standard bead lever tool
- Forge steel with chrome metal plate finish
- Length: 22" (55.88 cm), weight: 4 lbs (1.8 kg)





QVC QUICK VALVE CHANGE TOOL

51025

QVC QUICK VALVE CHANGE TOOL

From cars to trucks, ATV's and motorcycles, all of these vehicles suffer from bothersome leaky or broken valve stems. Aluminum car wheels are notorious for corrosion around the valve stem base allowing air to leak out. The QVC Quick Valve Change Tool allows the user to replace the valve stem without removing the tire from the wheel, saving time and money.

- Change a tire valve in 10 seconds
- Replace valve stem without removing the tire from the wheel
- Great for trailers and offroad vehicles
- Ideal for leaking valve stems
- For use only with .453 valve stems



**BEST
SELLER**

6 EASY STEPS

1. Deflate tire if not already flat, insert T-Handle between rim and valve stem
2. Turn T-Handle 1/4 turn to hook valve stem and pull out
3. Thread new valve stem on end of plunger rod, apply tire/rubber lubricant to the base of the valve stem
4. Position insertion cone over stem hole
5. Push plunger rod / valve stem assembly completely through insertion cone
6. Pull back to seat valve stem and un-thread

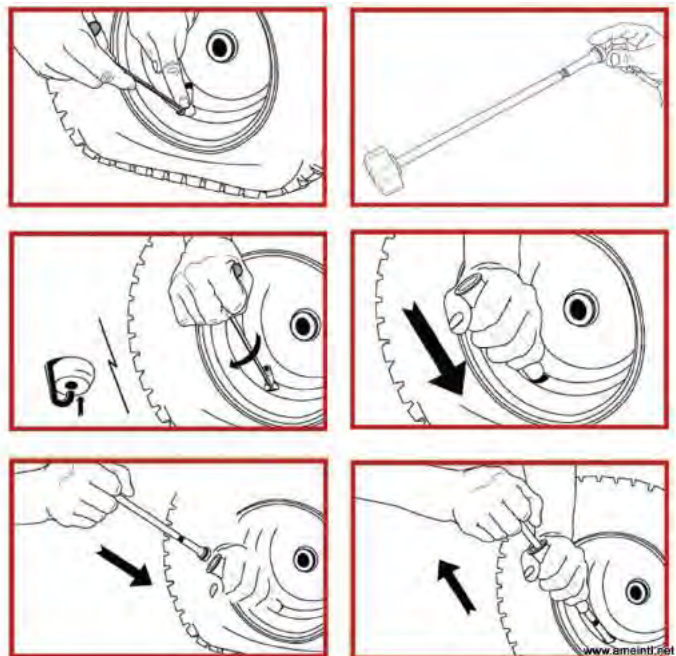

Not to be used on tires with TPMS –
Tire Pressure Mounting Systems.
Valve stems not included.



AC Hydraulic^{AS}
NO COMPROMISE

SD26PHL

AC HYDRAULIC^{AS} AIR HYDRAULIC JACKING BEAM

- Air hydraulic jacking beam for passenger cars and vans
- Quick and efficient lifting due to reliable and noiseless pump
- Low closed height - suitable for vehicles with a low clearance
- Flexible top support beam can be extended up to 63.4" (161 cm)
- Unique height adjustable support arm system – designed to fit all current lifts and pits
- Supplied with 3 extension sets 0.4" / 1.6" / 3.4" (1 / 4 / 8.5 cm) and rubber cushion for protection of car body
- Two-hand lowering operation with dead man's release, automatic safety locking device and overload valve for optimum safety
- Please always state lift type to get the correct support arm, should your lift not be in AC's support arm list then always fill in the specification form



Model	Capacity	Stroke	Min. Height	Telescopic Arms	Width (+ support arms)	Air Supply	Air Consumption	Weight (+ support arms)
SD26PHL	2.85 tons	9.84" (25 cm)	7.09" (18 cm)	30.71" - 63.39" (78 - 161 cm)	30.71" - 46.46" (78 - 118 cm)	8.5 - 12 bar	350 l/min	243 lb (110 kg)

WJN5 WJN10

AC HYDRAULIC^{AS} HYDRAULIC WORKSHOP CRANES

- Hydraulic workshop crane for auto workshops and service vans
- Foldable within seconds for quick and easy storage
- When folded the crane takes up a minimum of space on the workshop floor
- Jib arm with large lifting capacity – even in 5th position
- Hard chromium plated piston rod and pump piston for long life
- Built-in safety overload valve
- Fitted with 2 castors and 2 fixed wheels for easy maneuverability even with maximum load
- Lifting hook pivots 360°
- Hand operated dead man's release for optimum safety whilst lowering



Model	Capacity	Lifting Height	Jib Arm	Dimensions (L x W x H)	Inner Width	Weight
WJN5	0.6 tons	79.53" - 92.13" (202 - 234 cm)	37.6" - 54.13" (95.5 - 137.5 cm)	55.21" (142 cm) x 42.52" (108 cm) x 59.84" (152 cm)	37.6" (95.5 cm)	165 lbs (75 kg)
WJN10	1.2 tons	79.53" - 92.13" (202 - 234 cm)	37.6" - 54.13" (95.5 - 137.5 cm)	55.21" (142 cm) x 43.7" (111 cm) x 59.84" (152 cm)	38.78" (98.5 cm)	200 lbs (95 kg)



REPAIR PARTS: HYDRAULIC BEAD BREAKERS

These OEM parts will work with all IMT, FEC, Stellar, and Esco branded bead breakers built before 2015

11000-005
HEX. HD. SCREW



11030-007
SHOULDER BOLT



11000-006
PRESSURE NUT
W/ RETAINING RING



11030-008
PRESSURE NUT



11000-007
HOOK



11010-049
CAP SCREW FOR
11010-050



11000-008
SET SCREW

• 3/4 dia. x2- 1/4 Lg., Torque to 40/60/ Ft. lbs.

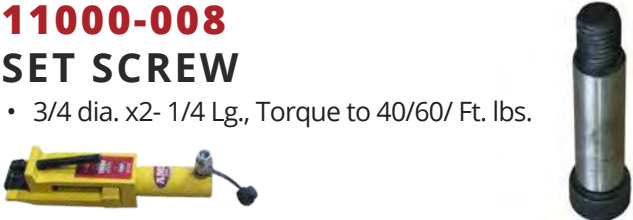

11010-022
CENTER CLAW

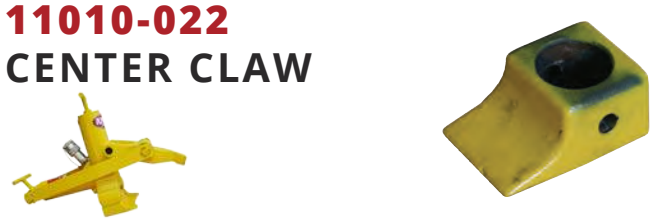

11000-009
CLEVIS



11010-050
REPLACEABLE TOOTH

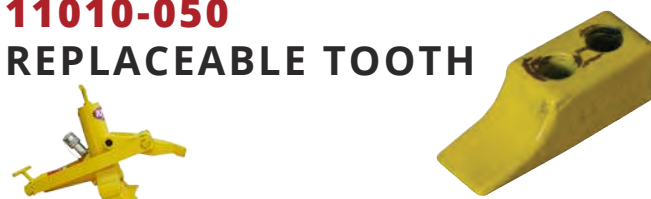

11030-004
HOOK



11010-051
CLAMPING BOLT



11030-006
SET SCREW



11010-052
CLAMPING SPACER



REPAIR PARTS: AIR/HYDRAULIC PUMPS



These OEM parts will work with all IMT, FEC, Stellar, and Esco branded pumps

15000-94
FOOT PEDAL



15900-001
FOOT PEDAL



15000-95
SHOULDER SCREW



15900-002
RETAINING RING



15000-150
COVER ASSEMBLY



15900-003
PIN



15000-168
POPPET ASSEMBLY



15900-078
U-CUP &
BACK-UP KIT



15000-159
GASKET SET



15900-079
RETAINER



15000-163
AIR BUTTON
KIT



15900-082
PISTON



15000-AMK
AIR MOTOR
KIT



15900-RK
REPAIR KIT, 15900



15000-PK
HYDRAULIC
PUMP KIT



15920-RK
REPAIR KIT, 15920



15000-RVK
RELEASE
VALVE KIT



15940-RK
REPAIR KIT, 15940











TOOL REPAIR PROGRAM



If we cannot repair your tool, no one can!
We offer:

-  **In-House Factory Repairs**
-  **Guaranteed Repairs**
-  **Original Parts Inventory - not aftermarket**
-  **Fast Turnaround - Same Day Estimates & Repairs**
-  **Easy Pick Up Using Prepaid UPS Shipping Tags**
-  **FREE Telephone Trouble Shooting - 877-755-4AME (4263)**
-  **Repair ALL makes and brands of tools, including IMT, FEC, Stellar, and Esco**

The easiest way to request a repair is through www.ameintl.net/repairs where you can:

- Notify AME of an incoming repair
- Print your own UPS label
- Receive your Return Goods number

If you already have an AME Tool Repair Kit or prefer not to fill out online, fill out the Repair Request for Estimate form.

TOOL REPAIR WITHIN 6 EASY STEPS:

1. Call AME International at **877-755-4AME (4263)** to obtain RGA # for the return.
2. Package the item(s) in a cardboard box; please place any pumps that are leaking in a plastic garbage bag to contain any fluids leaked during shipment.
3. Place the pre-addressed, prepaid UPS label onto the outside of the box. Be sure to note the tracking number on the UPS label for your records.
4. Place the completed repair ticket into the clear plastic sleeve onto the outside of the box.
5. Give the package to any UPS driver or drop the package off at the nearest UPS center or drop-box.
6. Your tool will be estimated within 24 hours of receipt and repaired within 24 hours of approval.

For more details on our hydraulic repair program, please visit our repair page at www.ameintl.net/repairs or call **877-755-4AME (4263)**

BUYBACK PROGRAM



Turn your tools into CASH!

If AME International cannot repair your tool - we'll buy it!
We pay \$50 for hydraulic pumps and \$75 for hydraulic bead breakers.

\$75 TOOL BUYBACK



**WE'LL BUY BACK ANY
HYDRAULIC BEAD BREAKER -
ANY BRAND - ANY CONDITION!**

See back for details

\$50 PUMP BUYBACK



**WE'LL BUY BACK ANY
AIR/HYDRAULIC PUMP -
ANY BRAND - ANY CONDITION!**

See back for details

For more details on our tool buyback program, please visit our repair page at
www.ameintl.net/repairs or call 877-755-4AME (4263)



BUYBACK PROGRAM

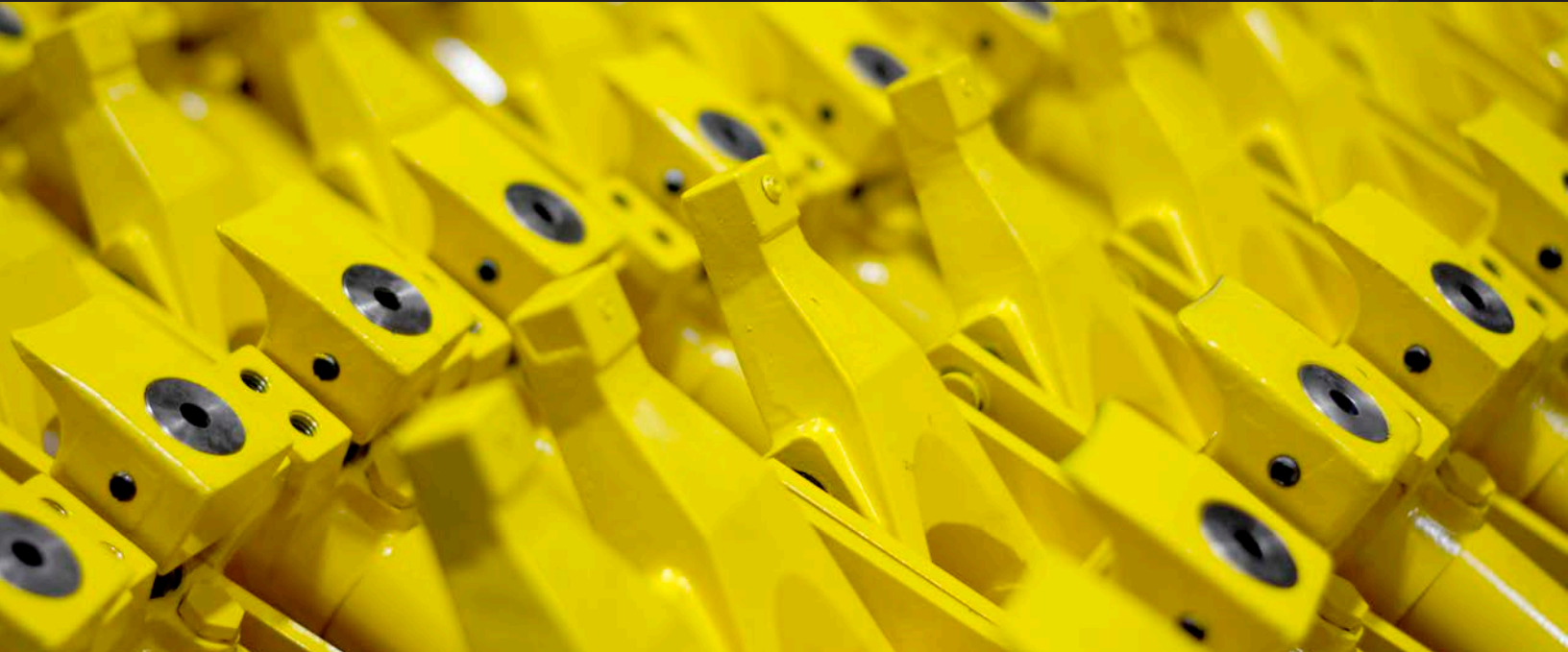

Turn your tools into CASH!

If AME International cannot repair your tool - we'll buy it!
We pay \$50 for hydraulic pumps and \$75 for hydraulic bead breakers.

\$50 PUMP BUYBACK

Please fill out your address below and mail this along with any air/hydraulic pump to be returned. We'll pay \$50 for each air/hydraulic pump that is returned.

Company _____

Name _____

Address _____

City _____

State _____ Zip _____

Tel _____

Email _____

Number of pumps returned _____

\$75 TOOL BUYBACK

Please fill out your address below and mail this along with hydraulic bead breaker to be returned. We'll pay \$75 for each hydraulic bead breaker that is returned.

Company _____

Name _____

Address _____

City _____

State _____ Zip _____

Tel _____

Email _____

Number of bead breakers returned _____

For more details on our tool buyback program, please visit our repair page at www.ameintl.net/repairs or call 877-755-4AME (4263)

SUBSCRIBE TO OUR YouTube CHANNEL

YOUTUBE.COM/USER/AMEINTLVIDEOS



For videos on:

- Product Specs
- "How-To" Videos
- Troubleshooting
- Maintenance
- Repair

NOW AVAILABLE!



- Parts Breakdowns
- Manuals
- Repair Guides

What puts AME International ahead of the competition?

We are the complete tire service solution!

Visit www.ameintl.net for detailed parts breakdowns.



INDEX

Product	Page(s)	Product	Page(s)	Product	Page(s)
25-1	70	13095	27	15310	63
25-1H	70	13100	27	15315	63
25-2	70	13120	28, 35, 36	15320	63
50-2	70	13121	23, 25, 28, 35, 36	15321	62
50-3	70	13121-SBK	36	15322	62
65-1AP	93	13122	36	15324	64
65-1APH	93	13140	28, 35, 36	15325	64
65-1h	93	13154	28, 36	15336	60
89-F17	76	13155	28, 36	15336-BR	61
89MTIS-5	76	14140	67	15337	60
89TWIN-DS	76	14160	67	15337-BR	61
89XDB	76	14180	67	15338	60
89XTC	76	14300	92	15338-BR	61
100-1	47	14303	92	15339	60
100-1H	47	14320	92	15339-BR	61
100-1L	47	14350	92	15341	60
150-1	47	14360	68, 92	15342	60
150-1H	47	14370	92	15342-BR	61
150-1L	47	14400	69	15345	65
11000	12, 19, 23, 25, 28, 110	14405	69	15346	65
11001	13	14410	69	15347	65
11001-006	13	14415	69	15348	65
11001-021	13	14425	69	15349	65
11001-022	13	14460	66	15350	65
11001-023	13	14461	66	15351	65
11001-024	13	14462	37	15352	65
11002	17, 21	14463	37	15353	60
11005	13	14464	37	15353-BR	61
11010	8, 19, 28, 110	14465	37	15355	64
11015	8, 19	14466	37	15360	65
11020	9, 19, 28	14468	37	15366	64
11030	16, 19, 28, 110	14468LT	37, 55	15367	64
11031	16	14469	37	15667	56
11040	16, 28	14470	66	15668	36, 56
11043	15	14472	37	15669	56
11044	14, 15, 19, 25	14473	37	15900	19, 28, 31, 111
11046	15	14475	66	15901	31
11049	15	14720	68, 98	15905	29
11050	13, 28	14980	68, 98	15906	29
11055	14	14985	68, 93	15907	29
11060	17, 28	15000	19, 28, 30, 111	15920	19, 23, 25, 28, 31, 111
11065	17	15001	19, 32	15921	31
11070	10	15002	57	15924	29
11076	9, 10, 19	15012	23, 25, 57	15925	29
11077	10	15020	28, 30	15930C	31
11080	17, 28	15022	23, 25, 57	15940	19, 28, 31, 111
11090	9, 28	15025	19, 28, 30	16000	32
11144	15	15032	23, 25, 57	16010	32
11145	15	15040	19, 28, 30	16015	32
11244	15	15081	32	16016	32
11344	15	15090	18	16020	32
11900	25, 50	15091	18	16020-TC	32
12000-12091	19	15095	18	16025	32
12105	12	15096	18	16025-TC	32
12150	16	15097	18	16030	32
12160	16	15098	18	16030-TC	32
13000	21, 23, 25, 28, 34	15100	18	16035	32
13005	34	15101	18	16035-TC	32
13010	27	15231	56	16040	32
13020	27	15232	56	16045	32
13030	27	15245	56	16050	23, 25, 32
13040	27	15255	55	16060	32
13050	27	15260	55	16070	12
13060	27	15300	62	16100	23, 25, 28, 32
13075	27	15301	62	16100-TC	32
13076	27	15305	63	16105	28, 32
13081	28, 34	15308	64	16105-TC	32
13090	27	15309	64	16110	28, 32



Product	Page(s)	Product	Page(s)	Product	Page(s)
16110-TC	32	58034	86	79040	106
16116	28, 32	58035	86	91000	48
16116-TC	32	58036	86	92000	49
16120	28, 32	61000	85	92200	49
16120-TC	32	61010	85	92250	49
16150	10	61020	85	93000	23, 25, 48
16160	32	61030	85	94000	51
16160-TC	32	61040	85	94010	23, 25, 51
16200	10	61050	85	94020	51
16270	14, 16	61060	85	139987	87
17200	10	61070	85	A-64	12
21000	89	61080	85	<u>AC Hydraulic</u> ^{AVS}	
21010	89	61090	85	Mining Jacks	47
22000	89	62030	82	Air Hydraulic Jacks	70, 71
22020	89	63000	85	Wheel Trolleys	81
22040	89	63010	85	Aircraft Jacks	93
23800	89	63010-001	85	Heavy Duty Air Hydraulic Jack	93
24145	73	67000	83	Hydraulic Jacks	96
24420	72	67125	83	Transmission Jacks	97
24425	72	67150	83	Jacking Beams	109
24430	72	67300	82	Cranes	109
24440	72	67301	98	B25-2	70
24450	72	69270	103	BHD	47
24455	72	69290	85	CD-411	32
24456	72	71000	78	DK13HLQ	96
24820	73	71025	79	DK20HLQ	96
24860	73	71026	79	DK20Q	96
24866	74	71027	79	FHD100	47
24867	74	71050	77	FHD200	47
24868	75	71100	106	GL-1001	87
24869	75	71300	80	GL-1002	87
26110	90	71320	80	GL-2001	87
26140	91	71335	80	GL-2002	87
26148	90	71410	78	GL-2301	87
26155	90	71412	79	GL-2919	87
26156	90	71413	79	GL-2928	87
26157	90	71500	88	GL-2939	87
26158	90	71600	88	GS-1	96
26159	90	71635	78, 79	<u>Haltec</u> Inflators	76
31210	84	71670	50	HHD	47
31250	84	72000	104	Jack Plates	37
31270	84	72001	104	LOTRTP	24, 25
36000	6	72005	105	MWAGTP	20, 21
36100	6	72010	104	Pow'r-Riser II®	42, 43
36200	6	72020	104	PTW-Series	38, 39
36205	6	72040	104	Repair Parts: Air/Hydraulic Pumps	111
37330	99	72080	107	Repair Parts: Hydraulic Bead Breakers	110
37335	99	72081	107	Rhino Jack II	41
39946	87	72082	107	SB65	47
51025	108	72083	107	SB100	47
51070	102	72084	107	SB150	47
51140	102	72085	107	SD26PHL	109
51170	102	72100	103	SLJ Series	44, 45, 46
51200	100	72105	103	SOTRTP	20, 21, 22, 23
51210	100	72110	107	SuperStacker™ Cribbing	54, 55
51220	100	72120	107	TC-370A	32
51250	100	72140	107	TC-371A	32
51290	100	72150	78	TC-372A	32
51300	101	72210	105	Truck Wheel Guards	85
51310	101	72220	105	VL6	97
51410	101	73080	95	VL10	97
51456	21, 23, 25, 102	73100	94	VLT6	97
51460	102	73200	94	VLT12	97
51470	102	73210	95	WJN5	109
51480	101	75005	8, 21, 23, 25	WJN10	109
51500	105	79010	106	WT1500	81
51550	105	79020	106	WTA500	81
58033	86	79030	106	WTK	81



TIRE SERVICE SOLUTIONS

2016/17 TOOL & EQUIPMENT CATALOG

WWW.AMEINTL.NET

PHONE: 352.799.1111 FAX: 352.799.1112
2347 CIRCUIT WAY, BROOKSVILLE, FL 34604